

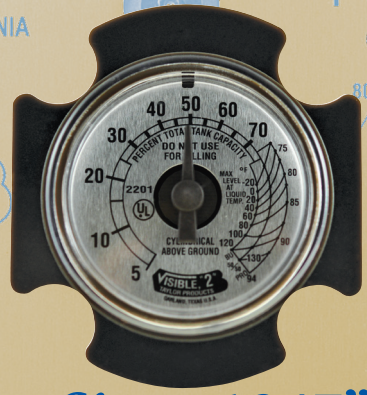

TAYLOR PRODUCTS

Gauge Catalog

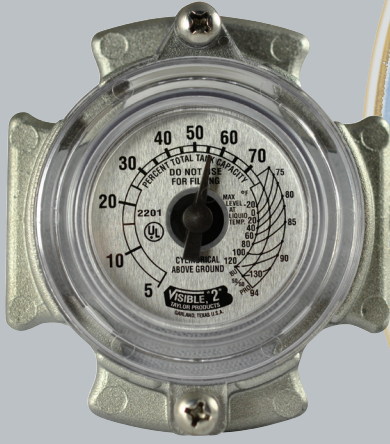
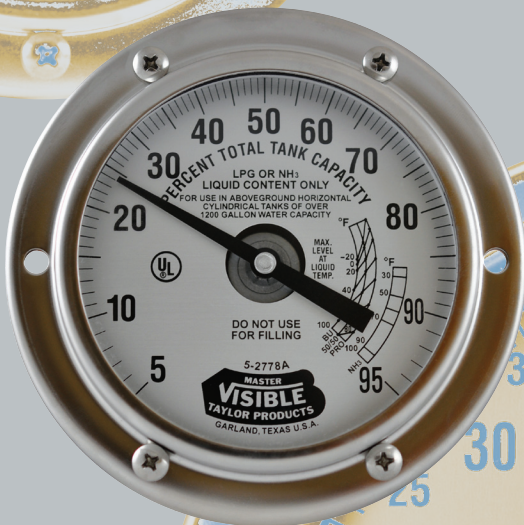
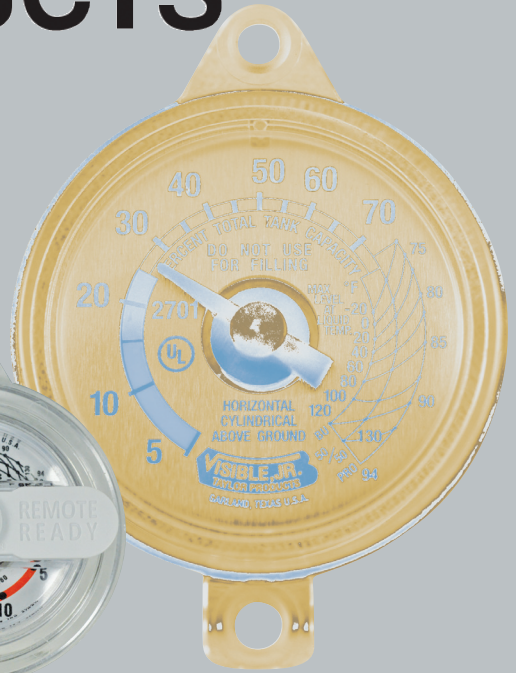
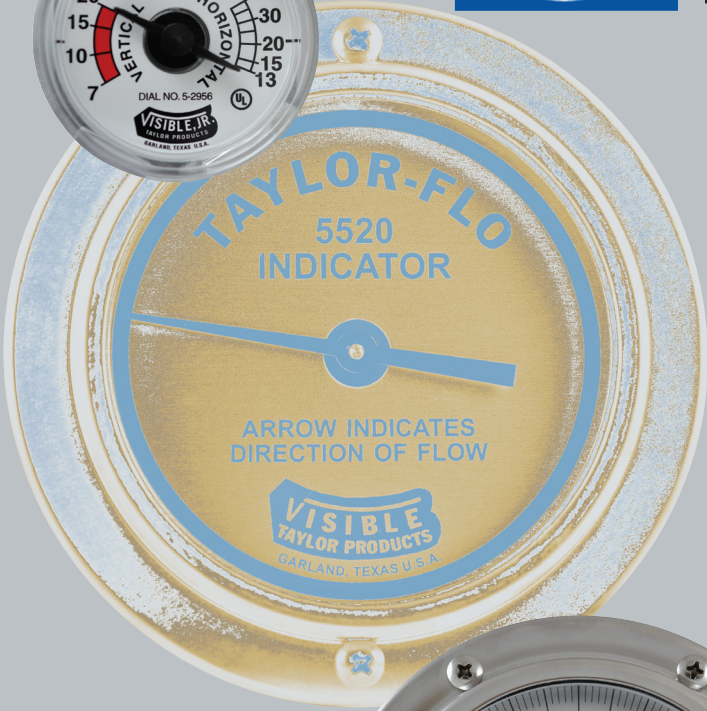

"Your Gauge Company Since 1947"

Table Of Contents

Gauges	
Junior Above Ground LP Gauges	Page 1
Junior Below Ground LP Gauges	Page 2
Junior Motorfuel LP Gauges	Page 3
Senior Above Ground LP Gauges	Page 4
3/4" Threaded LP Gauges	Page 5
1" Threaded LP Gauges	Page 6
1 1/4" Threaded LP Gauges	Page 7
Vertical Cylinder LP Gauges	Page 8
Lift Truck LP Gauges	Page 9
Senior NH3 Gauges	Page 10
N-Serve SS Gauges	Page 11
Junior NH3 Gauges	Page 12
Flow Indicator	Page 13
RoadMaster Mobile Applications & Parts	Page 14-15
Master Gauges & Parts	Page 16-17
The Eliminator™	Page 18
Rotary Gauges	Page 19
Monitors	
Stationary Tank Monitor & HE-2 Conversion Kit	Page 20
R3D Modules, Reed Switches, Sender, & Storage Tank Monitor Parts	Page 21
Dials	
Above Ground LP Dials	Page 22
Below Ground & Motor Fuel LP Dials	Page 23
Lift Truck LP Dials	Page 24
Vertical Cylinder LP Dials	Page 25
Glue-On ViSible 2" , ViSible 4" , & Master 8" LP Dials	Page 26
NH3 Dials	Page 27
Combination LP & NH3 - ViSible 4" & RoadMaster 4" Dials	Page 28
Combination LP & NH3 - Master 8" Dials	Page 29-30
Dial Brackets, Dial Screws, & Broken Screw Kit	Page 31
Ordering Information	
Gauge Ordering Information	Page 32
Gauge Reference Information	Page 33
Dial Ordering Information	
ViSible 2" & ViSible 4"	Page 34
Master 8" Dials	Page 35
Dial Installation	
Glue-On Replacement & ViSible 4"	Page 36
ViSible 4" & Master 8" Dials	Page 37
Master 8" Dials	Page 38

Junior Above Ground LP Gauges

Float Gauges are designed to indicate the liquid level contents of LP-Gas Containers. These gauges mount in a Junior flanged coupling with a 2 1/32" diameter bolt circle.

Junior gauges are supplied standard with Buna-N gasket and four zinc-plated steel mounting screws (1/4"-28 X 7/8"). These gauges are available in top, side or end, and angle mounting for above ground tanks. **Note:** *Torque mounting bolts evenly to 35 In/Lbs.*

Junior LP Standard Sizes										
Item Number	Part Number	"H"	Tank Diameter	Head Type	Mount	Case Quantity	Replacement Dials			
							Drop-In Dial	Drop-In R3D Dial	Tabbed Dial	Tabbed R3D Dial
130299	JA124IP	1/2"	24"	Alum.	Top	50 Pcs.	130012	130022	130021	130082
130305	JA154IP	1/2"	30"	Alum.	Top	50 Pcs.	130012	130022	130021	130082
130310	JA192J	1/2"	37"	Alum.	Top	50 Pcs.	130012	130023	130021	130082
130315	JA206IP	1/2"	41"	Alum.	Top	50 Pcs.	130012	130022	130021	130082
130301	JC124B	1/2"	24"	Alum.	45°	50 Pcs.	130012	130022	130021	130082
130303	JC154A	1/2"	30"	Alum.	45°	50 Pcs.	130012	130022	130021	130082
130307	JC190B	1/2"	37"	Alum.	45°	50 Pcs.	130012	130022	130021	130082
130312	JC210B	1/2"	41"	Alum.	45°	50 Pcs.	130012	130022	130021	130082
130316	JD080D	1/2"	24"	Alum.	End	50 Pcs.	130012	130022	130021	130082
130318	JD100F	1/2"	30"	Alum.	End	50 Pcs.	130012	130022	130021	130082
130320	JD120D	1/2"	37"	Alum.	End	50 Pcs.	130012	130022	130021	130082
130322	JD140C	1"	41"	Alum.	End	50 Pcs.	130012	130022	130021	130082

"H" = Distance from tank surface to center of thread.

Junior Gauge Parts		
Item Number	Part Number	Case Quantity
130118	Jr. Gauge Screw	50 Pcs.
130121	Jr. Gauge Gasket Buna-N	50 Pcs.
130134	Jr. Gauge Gasket Teflon	1 Pc.
403014	Jr. Gauge O-Ring	1 Pc.
130101	Jr. Gauge Head Only	1 Pc.

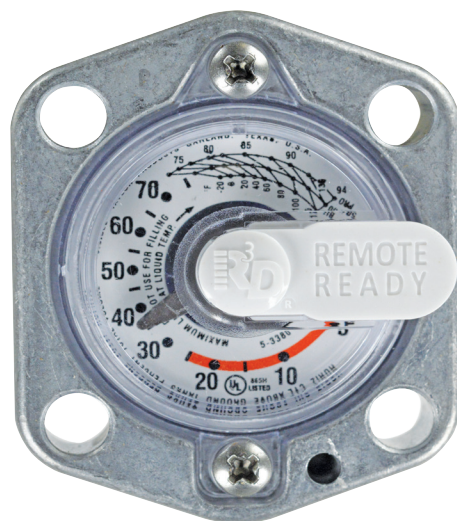

"We Specialize in Custom Size Gauges"

Float Gauges are designed to indicate the liquid level contents of LP-Gas Containers. These gauges mount in a Junior flanged coupling with a 2 1/32" diameter bolt circle.

Junior gauges are supplied standard with Buna-N gasket and four zinc-plated steel mounting screws (1/4"-28 X 7/8").

Note: *Torque mounting bolts evenly to 35 In/Lbs.*

Junior LP Standard Sizes										
Item Number	Part Number	"H"	Tank Diameter	Head Type	Mount	Case Quantity	Replacement Dials			
							Drop-In Dial	Drop-In R3D Dial	Tabbed Dial	Tabbed R3D Dial
130520	JB302AP-1	18 1/4"	24"	Alum.	Top	50 Pcs.	130011	130024	N/A	130083
131550	JB340A	22"	24"	Alum.	Top	50 Pcs.	130011	130024	N/A	130083
130522	JB332AP-1	18 1/4"	30"	Alum.	Top	50 Pcs.	130011	130024	N/A	130083
131551	JB370C	22"	30"	Alum.	Top	50 Pcs.	130011	130024	N/A	130083
130524	JB370GP-1	18 1/4"	37"	Alum.	Top	50 Pcs.	130011	130024	N/A	130083
131552	JB404D	22"	37"	Alum.	Top	50 Pcs.	130011	130024	N/A	130083
130526	JB382BP-1	18 1/4"	41"	Alum.	Top	50 Pcs.	130011	130024	N/A	130083
131553	JB424C	22"	41"	Alum.	Top	50 Pcs.	130011	130024	N/A	130083

"H" = Distance from tank surface to center of thread.

Junior Gauge Parts		
Item Number	Part Number	Case Quantity
130118	Jr. Gauge Screw	50 Pcs.
130121	Jr. Gauge Gasket Buna-N	50 Pcs.
130134	Jr. Gauge Gasket Teflon	1 Pc.
403014	Jr. Gauge O-Ring	1 Pc.
130101	Jr. Gauge Head Only	1 Pc.

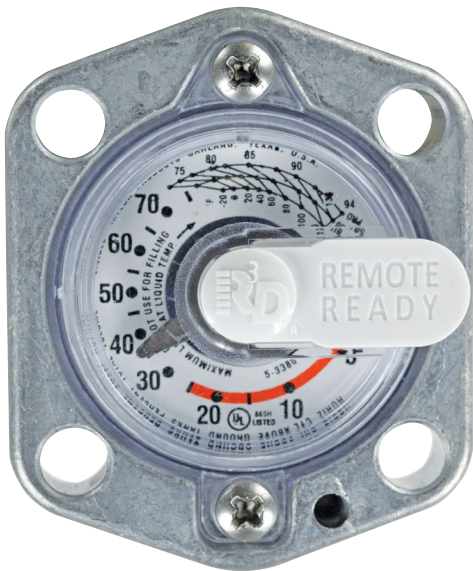

Junior Motorfuel LP Gauges

Float Gauges are designed to indicate the liquid level contents of LP-Gas Containers. These gauges mount in a Junior flanged coupling with a 2 1/32" diameter bolt circle.

Junior gauges are supplied standard with Buna-N gasket and four zinc-plated steel mounting screws (1/4"-28 X 7/8"). These gauges are available in top, side or end, and angle mounting for motorfuel tanks. **Note:** *Torque mounting bolts evenly to 35 In/Lbs.*

Junior LP Standard Sizes								
Item Number	Part Number	"H"	Tank Diameter	Head Type	Mount	Case Quantity	Replacement Dials	
							Drop-In Dial	Tabbed Dial
130247	10CC	-3/8"	10"	Aluminum	Side, End	50 Pcs.	136000	136005
130248	12CC	-3/8"	12"	Aluminum	Side, End	50 Pcs.	136000	136005
130250	14CC	-3/8"	14"	Aluminum	Side, End	50 Pcs.	136000	136005
130251	16CC	-3/8"	16"	Aluminum	Side, End	50 Pcs.	136000	136005
130252	18CC	-3/8"	18"	Aluminum	Side, End	50 Pcs.	136000	136005
130253	20CC	-3/8"	20"	Aluminum	Side, End	50 Pcs.	136000	136005
130254	22CC	-3/8"	22"	Aluminum	Side, End	50 Pcs.	136000	136005
130255	24CC	-3/8"	24"	Aluminum	Side, End	50 Pcs.	136000	136005
130249	12AC	-3/8"	12"	Aluminum	45° Angle	50 Pcs.	136000	136005
130256	14AC	-3/8"	14"	Aluminum	45° Angle	50 Pcs.	136000	136005
130257	16AC	-3/8"	16"	Aluminum	45° Angle	50 Pcs.	136000	136005
130258	18AC	-3/8"	18"	Aluminum	45° Angle	50 Pcs.	136000	136005
130259	20AC	-3/8"	20"	Aluminum	45° Angle	50 Pcs.	136000	136005
130260	22AC	-3/8"	22"	Aluminum	45° Angle	50 Pcs.	136000	136005
130261	24AC	-3/8"	24"	Aluminum	45° Angle	50 Pcs.	136000	136005

"H" = Distance from tank surface to center of thread.

Junior Gauge Parts		
Item Number	Part Number	Case Quantity
130118	Jr. Gauge Screw	50 Pcs.
130121	Jr. Gauge Gasket Buna-N	50 Pcs.
130134	Jr. Gauge Gasket Teflon	1 Pc.
403014	Jr. Gauge O-Ring	1 Pc.
130101	Jr. Gauge Head Only	1 Pc.

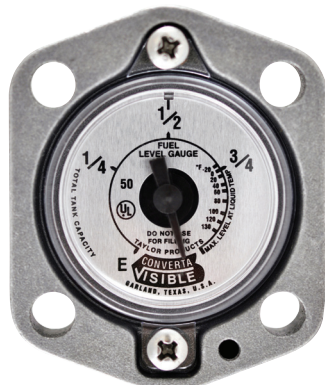

"We Specialize in Custom Size Gauges"

Float Gauges are designed to indicate the liquid level contents of LP-Gas Containers. These gauges mount in a Senior flanged coupling with a 2 1/2" diameter bolt circle.

Senior gauges are supplied standard with Buna-N gasket and four zinc-plated steel mounting screws (5/16"-24 X 7/8"). These gauges are available in top, side or end, and angle mounting for above ground tanks. A Visible "4" Dial is available.

Note: Torque mounting bolts evenly to 100 In/Lbs.

Senior LP Standard Sizes										
Item Number	Part Number	"H"	Tank Diameter	Head Type	Mount	Case Quantity	Replacement Dials			
							Drop-In Dial	Drop-In R3D Dial	Tabbed Dial	Tabbed R3D Dial
130324	SA130A	1"	24"	Alum.	Top	50 Pcs.	130009	130023	130037	403594
130326	SA160A	1"	30"	Alum.	Top	50 Pcs.	130009	130023	130037	403594
130328	SA194A	1"	37"	Alum.	Top	50 Pcs.	130009	130023	130037	403594
130330	SA214A	1"	41"	Alum.	Top	50 Pcs.	130009	130023	130037	403594
130332	SC130B	1"	24"	Alum.	45°	50 Pcs.	130012	130022	130037	403594
130334	SC160A	1"	30"	Alum.	45°	50 Pcs.	130012	130022	130037	403594
130336	SC194D	1"	37"	Alum.	45°	50 Pcs.	130012	130022	130037	403594
130338	SC214C	1"	41"	Alum.	45°	50 Pcs.	130012	130022	130037	403594
130340	SD080D	1"	24"	Alum.	End	50 Pcs.	130012	130022	130037	403594
130342	SD100C	1"	30"	Alum.	End	50 Pcs.	130012	130022	130037	403594
130344	SD120G	1"	37"	Alum.	End	50 Pcs.	130012	130022	130037	403594
130346	SD140A	1"	41"	Alum.	End	50 Pcs.	130012	130022	130037	403594

"H" = Distance from tank surface to center of thread.

Senior Gauge Parts		
Item Number	Part Number	Case Quantity
130119	Sr. Gauge Screw	50 Pcs.
130122	Sr. Gauge Gasket Buna-N	50 Pcs.
130130	Sr. Gauge Gasket Teflon	1 Pc.
130131	Sr. Gauge Gasket Spirotallic	1 Pc.
403013	Sr. Gauge O-Ring	1 Pc.
130104	Sr. Gauge Head Only	1 Pc.

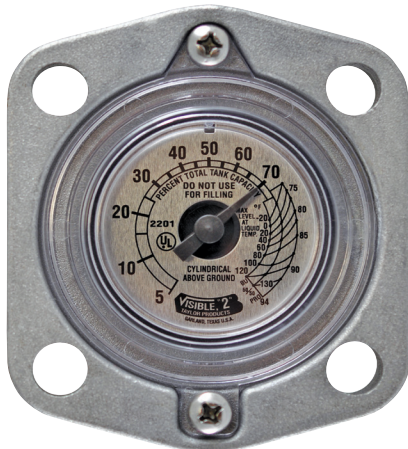

3/4" Threaded LP Gauges

Float Gauges are designed to indicate the liquid level contents of LP-Gas Containers. These gauge mount in a 3/4" tank coupling.

The UA series gauges are only for top mount applications in an above ground tank. These come standard with a 3/4" threaded zinc head with a 2" hex wrenching flat and junior tabbed dial.

Note: Torque head evenly to 50 to 100 Ft/Lbs.

3/4" Threaded Domestic Standard Sizes										
Item Number	Part Number	"H"	Tank Diameter	Head Type	Mount	Case Quantity	Replacement Dials			
							Drop-In Dial	Drop-In R3D Dial	Tabbed Dial	Tabbed R3D Dial
131640	UA130A-A	1"	24"	3/4" Zinc	Top	50 Pcs.	130012	130022	130052	N/A
131645	UA160A	1"	30"	3/4" Zinc	Top	50 Pcs.	130012	130022	130052	N/A
131650	UA194A-A	1"	37"	3/4" Zinc	Top	50 Pcs.	130012	130022	130052	N/A
131655	UA210A	1"	41"	3/4" Zinc	Top	50 Pcs.	130012	130022	130052	N/A

3/4" Horizontal Standard Sizes										
Item Number	Part Number	"H"	Tank Diameter	Head Type	Mount	Case Quantity	Replacement Dials			
							Drop-In Dial	Drop-In R3D Dial	Tabbed Dial	Tabbed R3D Dial
131670	UD080A-A	1"	24"	3/4" Zinc	End	50 Pcs.	N/A	N/A	130043	N/A
131671	UD080B	1"	30"	3/4" Zinc	End	50 Pcs.	N/A	N/A	130043	N/A
131674	UD120A	1"	37"	3/4" Zinc	End	50 Pcs.	N/A	N/A	130043	N/A
131673	UD140A	1"	41"	3/4" Zinc	End	50 Pcs.	N/A	N/A	130043	N/A

"H" = Distance from tank surface to center of thread.

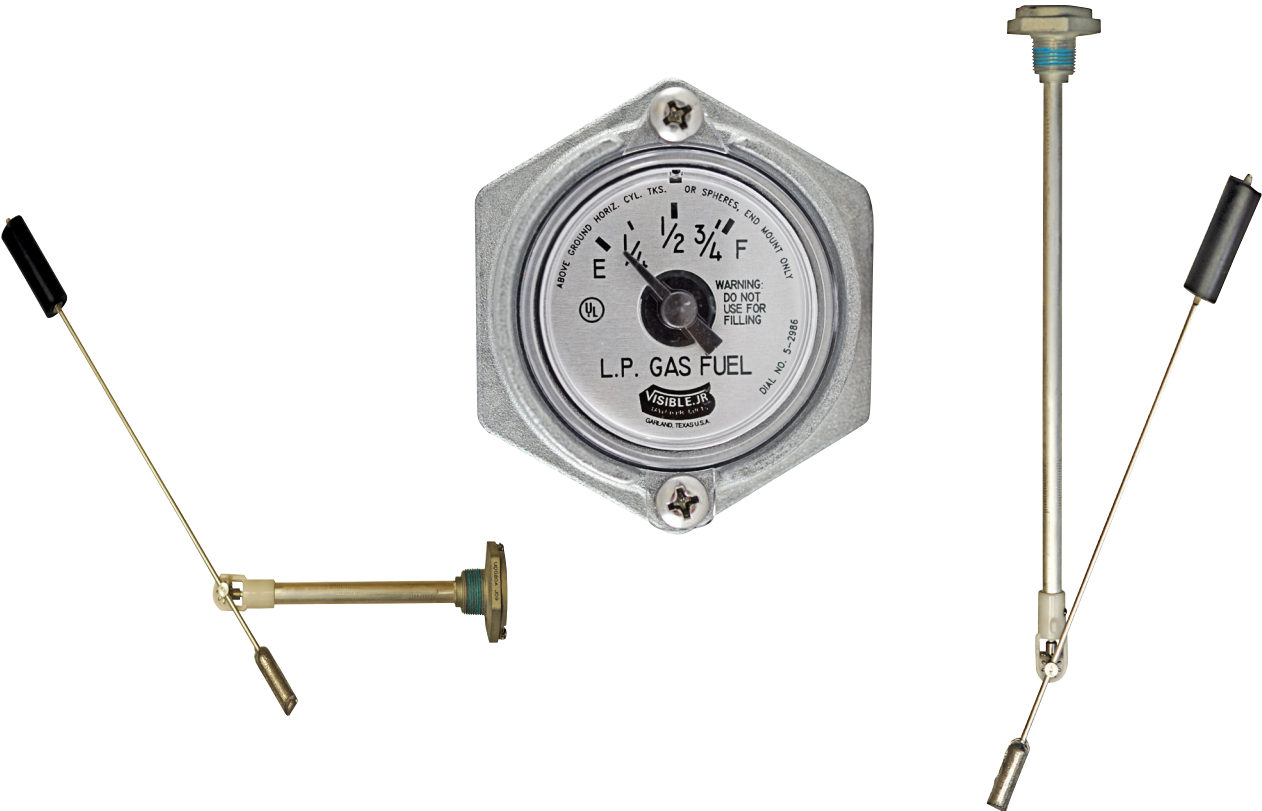

"We Specialize in Custom Size Gauges"

Float Gauges are designed to indicate the liquid level contents of LP-Gas Containers. These gauges mount in a 1" tank coupling.

The HA series gauges are only for top mount applications in an above ground tank. These come standard with a 1" threaded brass head with a 2" hex wrenching flat. **Note: Torque head evenly to 75 to 150 Ft/Lbs.**

1" Threaded Domestic Standard Sizes

Item Number	Part Number	"H"	Tank Diameter	Head Type	Mount	Case Quantity	Replacement Dials			
							Drop-In Dial	Drop-In R3D Dial	Tabbed Dial	Tabbed R3D Dial
131500	HA130AP-1	1"	24"	1" Brass	Top	50 Pcs.	130012	130022	130021	130082
131502	HA156AP-1	1"	30"	1" Brass	Top	50 Pcs.	130012	130022	130021	130082
131592	HA160AP	1"	30"	1" Brass	Top	50 Pcs.	130012	130022	130021	130082
131606	HA162B	1"	31.5"	1" Brass	Top	50 Pcs.	130012	130022	130021	130082
131595	HA194AP	1"	37"	1" Brass	Top	50 Pcs.	130012	130022	130021	130082
131506	HA210AP-1	1"	41"	1" Brass	Top	50 Pcs.	130012	130022	130021	130082

1" Threaded Vertical Cylinder Standard Sizes

Item Number	Part Number	"H"	Tank Size	Head Type	Mount	Case Quantity	Replacement Dials			
							Drop-In Dial	Drop-In R3D Dial	Tabbed Dial	Tabbed R3D Dial
131608	HA180AP	1"	200 Lb.	1" Brass	Top	50 Pcs.	130006	130039	130047	130038
131619	HA254JP-K	1"	420 Lb.	1" Brass	Top	50 Pcs.	130014	132765	N/A	130084

"H" = Distance from tank surface to center of thread.

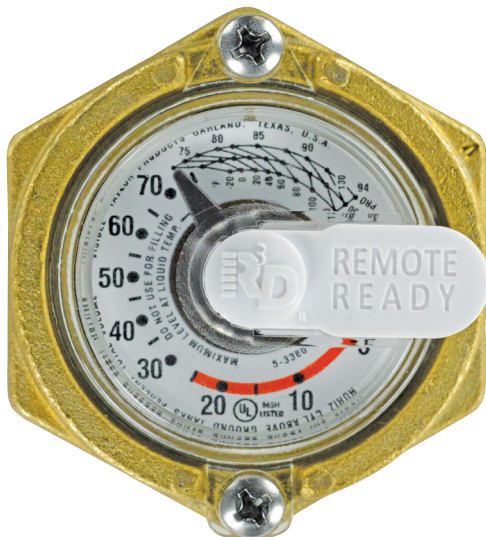

1 1/4" Threaded LP Gauges

Float Gauges are designed to indicate the liquid level contents of LP-Gas Containers. These gauges mount in a 1 1/4" tank coupling.

The TA series gauges are only for top mount applications in an above ground tank. These come standard with a 1 1/4" threaded brass head with a 2" hex wrenching flat. **Note: Torque head evenly to 100 to 200 Ft/Lbs.**

1 1/4" Threaded Domestic Standard Sizes										
Item Number	Part Number	"H"	Tank Diameter	Head Type	Mount	Case Quantity	Replacement Dials			
							Drop-In Dial	Drop-In R3D Dial	Tabbed Dial	Tabbed R3D Dial
131600	TA130AP	1"	24"	1 1/4" Brass	Top	50 Pcs.	130012	130022	130021	130082
131604	TA156AP	1"	30"	1 1/4" Brass	Top	50 Pcs.	130012	130022	130021	130082
131605	TA160AP	1"	30"	1 1/4" Brass	Top	50 Pcs.	130012	130022	130021	130082
131609	TA164AP	1"	32"	1 1/4" Brass	Top	50 Pcs.	130012	130022	130021	130082
131610	TA194AP	1"	37"	1 1/4" Brass	Top	50 Pcs.	130012	130022	130021	130082
131615	TA210AP	1"	41"	1 1/4" Brass	Top	50 Pcs.	130012	130022	130021	130082

1 1/4" Threaded Vertical Cylinder Standard Sizes										
Item Number	Part Number	"H"	Tank Size	Head Type	Mount	Case Quantity	Replacement Dials			
							Drop-In Dial	Drop-In R3D Dial	Tabbed Dial	Tabbed R3D Dial
131611	TA180A	1"	200 Lb.	1 1/4" Brass	Top	50 Pcs.	130006	130039	130047	130038
131616	TA254NS	1"	420 Lb.	1 1/4" Brass	Top	50 Pcs.	130014	132765	N/A	130084

"H" = Distance from tank surface to center of thread.

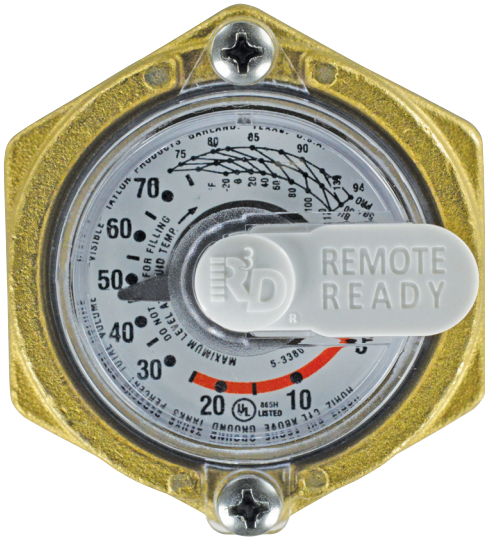

"We Specialize in Custom Size Gauges"

Float Gauges are designed to indicate the liquid level contents of LP-Gas Containers. These gauges mount in a Junior flanged, 1" or 1 1/4" tank coupling.

The JA series gauges are only for top mount applications in a vertical cylinder. These come standard with Buna-N gasket and four zinc-plated steel mounting screws (1/4"-28 X 7/8").

Note: Torque mounting bolts evenly to 35 In/Lbs.

The HA series gauges are only for top mount applications in a vertical cylinder. These come standard with a 1" threaded brass head with a 2" hex wrenching flat. **Note:** Torque head evenly to 75 to 150 Ft/Lbs.

The TA series gauges are only for top mount applications in a vertical cylinder. These come standard with a 1 1/4" threaded brass head with a 2" hex wrenching flat.

Note: Torque head evenly to 100 to 200 Ft/Lbs.

Junior Vertical Cylinder Standard Sizes

Item Number	Part Number	"H"	Tank Size	Head Type	Mount	Case Quantity	Replacement Dials			
							Drop-In Dial	Drop-In R3D Dial	Tabbed Dial	Tabbed R3D Dial
131545	JA176B	1/2"	200 Lb.	Alum.	Top	50 Pcs.	130006	130039	130047	130038
131540	JA250J	1/2"	420 Lb.	Alum.	Top	50 Pcs.	130014	132765	N/A	130084

1" Threaded Vertical Cylinder Standard Sizes

Item Number	Part Number	"H"	Tank Size	Head Type	Mount	Case Quantity	Replacement Dials			
							Drop-In Dial	Drop-In R3D Dial	Tabbed Dial	Tabbed R3D Dial
131608	HA180AP	1"	200 Lb.	1" Brass	Top	50 Pcs.	130006	130039	130047	130038
131619	HA254JP-K	1"	420 Lb.	1" Brass	Top	50 Pcs.	130014	132765	N/A	130084

1 1/4" Threaded Vertical Cylinder Standard Sizes

Item Number	Part Number	"H"	Tank Size	Head Type	Mount	Case Quantity	Replacement Dials			
							Drop-In Dial	Drop-In R3D Dial	Tabbed Dial	Tabbed R3D Dial
131611	TA180A	1"	200 Lb.	1 1/4" Brass	Top	50 Pcs.	130006	130039	130047	130038
131616	TA254NS	1"	420 Lb.	1 1/4" Brass	Top	50 Pcs.	130014	132765	N/A	130084

"H" = Distance from tank surface to center of thread.



Lift Truck LP Gauges

Float Gauges are designed to indicate the liquid level contents of LP-Gas Containers. These gauges mount in a Junior flanged, a 3/4" or a 1 1/4" tank coupling.

These gauges are for 20 Lb, 33 Lb., and 43 Lb. Lift Truck cylinders. The JU, TU, and UU series are Universal and will read either vertically or horizontally. The JA series are for vertical cylinders only. The JD060A and TU060A are for horizontal cylinders only. A 3/4" zinc head is optional on the UU series. **Note: Torque mounting bolts evenly to 35 In/Lbs. for Junior heads, 50-100 Ft/Lbs. for 3/4" Threaded, & 100-200 Ft/Lbs. for 1 1/4" Threaded.**

Lift Truck Standard Sizes								
Item Number	Part Number	"H"	Tank Size	Head Type	Mount	Case Quantity	Replacement Dials	
							Drop-In Dials	Tabbed Dials
131506	JU086B	1/2"	20 Lb.	Aluminum	Side, End	50 Pcs.	130002	N/A
131507	UU086B	1"		3/4" Snap-On	Side, End	50 Pcs.	130033	403582
131520	TU086B	1"		1 1/4" Brass	Side, End	50 Pcs.	130002	N/A
131512	JU160B	1/2"	33 Lb.	Aluminum	Side, End	50 Pcs.	130013	130081
131513	UU160B	1"		3/4" Snap-On	Side, End	50 Pcs.	130033	403582
131499	UU160E	1"		3/4" Zinc	Side, End	50 Pcs.	130033	130081
131530	TU160B	1"		1 1/4" Brass	Side, End	50 Pcs.	130013	130081
131516	JU212A	1/2"	43 Lb.	Aluminum	Side, End	50 Pcs.	130004	130051
131517	UU212A	1"		3/4" Snap-On	Side, End	50 Pcs.	130033	403582
131535	TU212A	1"		1 1/4" Brass	Side, End	50 Pcs.	130004	130048

Vertical Mount Standard Sizes								
Item Number	Part Number	"H"	Tank Size	Head Type	Mount	Case Quantity	Replacement Dials	
							Drop-In Dials	Tabbed Dials
131510	JA086A	1/2"	20 Lb.	Aluminum	Vertical	50 Pcs.	130009	N/A
131514	JA166A	1/2"	33 Lb.	Aluminum	Vertical	50 Pcs.	130009	N/A
131518	JA216A	1/2"	43 Lb.	Aluminum	Vertical	50 Pcs.	130009	N/A

Horizontal Mount Standard Sizes								
Item Number	Part Number	"H"	Tank Size	Head Type	Mount	Case Quantity	Replacement Dials	
							Drop-In Dials	Tabbed Dials
131508	JD060A	1/2"	20, 33,	Aluminum	Horizontal	50 Pcs.	130012	130021
131525	TD060A	1"	43 Lb.	1 1/4" Brass	Horizontal	50 Pcs.	130012	130021

"H" = Distance from tank surface to center of thread.

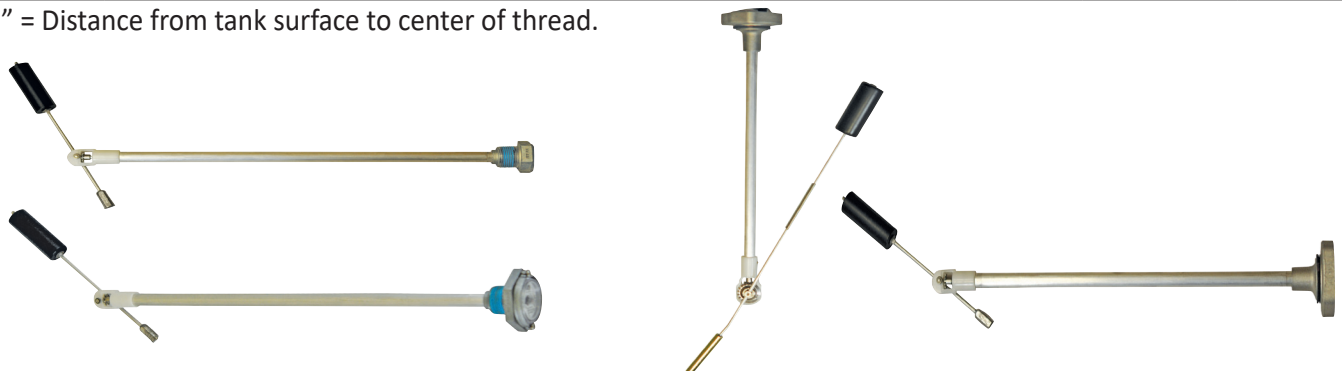

"We Specialize in Custom Size Gauges"

Float Gauges are designed to indicate the liquid level contents of Anhydrous-Ammonia(NH3) Containers. These gauges mount in a Senior flanged coupling with a 2 1/2" diameter bolt circle.

Senior gauges are supplied standard with Buna-N gasket and four zinc-plated steel mounting screws (5/16"-24 X 7/8"). These gauges are available in top, side or end, and angle mounting for above ground tanks. A Visible "4" Dial is available.

Note: Torque mounting bolts evenly to 100 In/Lbs.

Senior NH3 Standard Sizes								
Item Number	Part Number	"H"	Tank Diameter	Head Type	Mount	Case Quantity	Replacement Dials	
							Drop-In Dials	Tabbed Dials
130431	AA130A	1"	24"	Aluminum	Top	40 Pcs.	130018	130041
140433	AA160A	1"	30"	Aluminum		40 Pcs.	130018	130041
130435	AA194A	1"	37"	Aluminum		40 Pcs.	130018	130041
130437	AA214E	1"	41"	Aluminum		40 Pcs.	130018	130041
130425	AA240A	1"	46"	Aluminum		40 Pcs.	130018	130041
130426	AA250A	1"	48"	Aluminum		40 Pcs.	130018	130041
130440	AC130A	1"	24"	Aluminum	45° Angle	40 Pcs.	130018	130041
130443	AC160A	1"	30"	Aluminum		40 Pcs.	130018	130041
130444	AC194A	1"	37"	Aluminum		40 Pcs.	130018	130041
130447	AC214B	1"	41"	Aluminum		40 Pcs.	130018	130041
130449	AC240A	1"	46"	Aluminum		40 Pcs.	130018	130041
130450	AD080B	1"	24"	Aluminum		Side, End	40 Pcs.	130018
130452	AD100D	1"	30"	Aluminum	40 Pcs.		130018	130041
130455	AD120E	1"	37"	Aluminum	40 Pcs.		130018	130041
130457	AD140A	1"	41"	Aluminum	40 Pcs.		130018	130041
130427	AD150A	1"	46"	Aluminum	40 Pcs.		130018	130041
130459	AD160J	1"	48"	Aluminum	40 Pcs.		130018	130041

"H" = Distance from tank surface to center of thread.

Senior Gauge Parts		
Item Number	Part Number	Case Quantity
130119	Sr. Gauge Screw	50 Pcs.
130122	Sr. Gauge Gasket Buna-N	50 Pcs.
130130	Sr. Gauge Gasket Teflon	1 Pc.
130131	Sr. Gauge Gasket Spirotallic	1 Pc.
403013	Sr. Gauge O-Ring	1 Pc.
130104	Sr. Gauge Head Only	1 Pc.



N-Serve SS Gauges

Float Gauges are designed to indicate the liquid level contents of N-Serve Containers. These gauges mount in a Senior flanged coupling with a 2 1/2" diameter bolt circle.

Senior gauges are supplied standard with Buna-N gasket and four zinc-plated steel mounting screws (5/16"-24 X 7/8"). These gauges are available in top, side or end, and angle mounting for above ground tanks. A Visible "4" Dial is available.

Note: Torque mounting bolts evenly to 100 In/Lbs. for Buna-N and Teflon Gaskets. Torque mounting bolts evenly to 240 In/Lbs. for Spirotallic gasket.

Senior N-Serve SS Standard Sizes								
Item Number	Part Number	"H"	Tank Diameter	Head Type	Mount	Case Quantity	Replacement Dials	
							Drop-In Dials	Tabbed Dials
290000	AA41SS	1"	41"	Stainless Steel	Top	25 Pcs.	N/A	130041
290001	AA46SS	1"	46"	Stainless Steel	Top	25 Pcs.	N/A	130041

"H" = Distance from tank surface to center of thread.

Senior Gauge Parts		
Item Number	Part Number	Case Quantity
403631	SS Cap Screws	50 Pcs.
130119	Sr. Gauge Screw	50 Pcs.
130122	Sr. Gauge Gasket Buna-N	50 Pcs.
130130	Sr. Gauge Gasket Teflon	1 Pc.
130131	Sr. Gauge Gasket Spirotallic	1 Pc.
403013	Sr. Gauge O-Ring	1 Pc.
130104	Sr. Gauge Head Only	1 Pc.

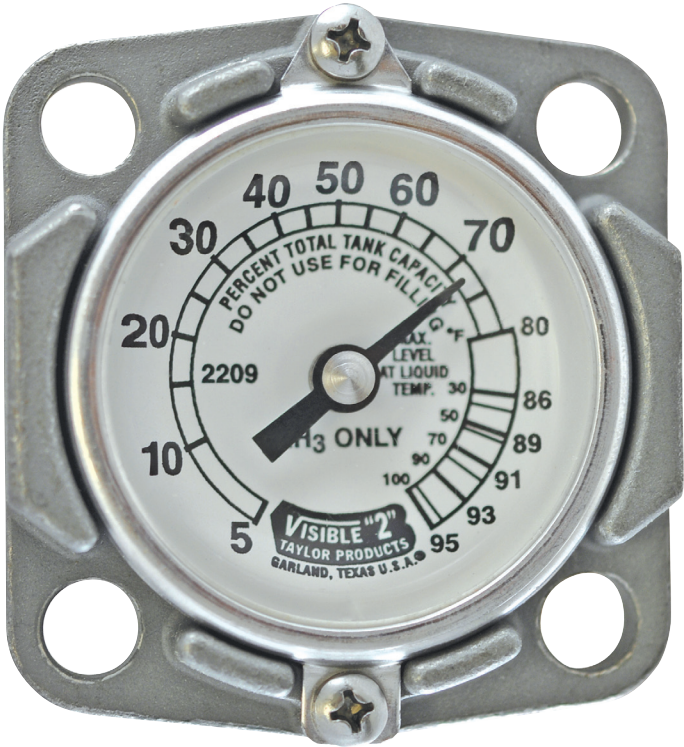

"We Specialize in Custom Size Gauges"

Float Gauges are designed to indicate the liquid level contents of Anhydrous-Ammonia(NH3) Containers. These gauges mount in a Junior flanged coupling with a 2 1/32" diameter bolt circle.

Junior gauges are supplied standard with Buna-N gasket and four zinc-plated steel mounting screws (1/4"-28 X 7/8"). These gauges are available in top, side or end, and angle mounting for above ground tanks.

Note: *Torque mounting bolts evenly to 35 In/Lbs.*

Junior NH3 Standard Sizes								
Item Number	Part Number	"H"	Tank Diameter	Head Type	Mount	Case Quantity	Replacement Dials	
							Drop-In Dials	Tabbed Dials
130400	BA124A	1/2"	24"	Aluminum	Top	50 Pcs.	130029	130049
130402	BA154A	1/2"	30"	Aluminum	Top	50 Pcs.	130029	130049
130403	BA214B	1/2"	41"	Aluminum	Top	50 Pcs.	130029	130049

"H" = Distance from tank surface to center of thread.

Junior Gauge Parts		
Item Number	Part Number	Case Quantity
130118	Jr. Gauge Screw	50 Pcs.
130121	Jr. Gauge Gasket Buna-N	50 Pcs.
130134	Jr. Gauge Gasket Teflon	1 Pc.
403014	Jr. Gauge O-Ring	1 Pc.
130101	Jr. Gauge Head Only	1 Pc.

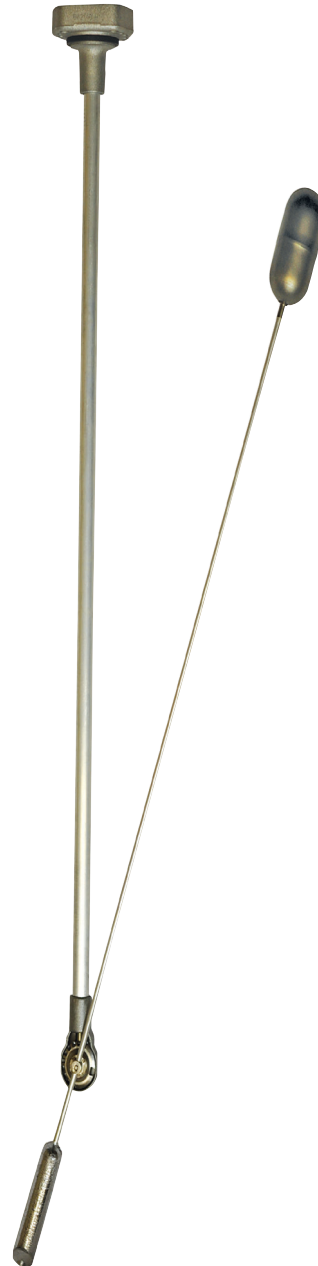
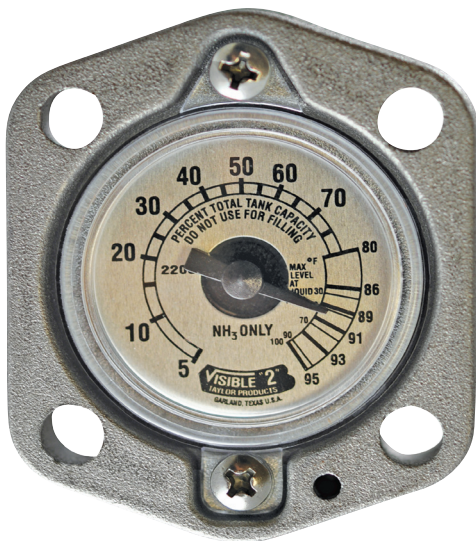

Flow Indicator

Indicates direction of flow of LP-Gas or Anhydrous Ammonia(NH3) in piping at working pressures up to 500 psig. The indicator must be installed in piping tees. The head, center shaft, support tube, bearings & vane in these indicators are made of 300 Series stainless steel. Magnets are nickel-plated Alnico, & the threaded mounting adapters are forged steel. The hermetically sealed dial has a large 4" dial face capable of showing flow in both directions or the absence of flow.

Note: Torque mounting bolts to 240 In/Lbs.

Flow Indicator Standard Sizes			
Item Number	Part Number	Pipe Size	Complete Assembly Includes
130050	5520-2 Complete	2"	5520-2 Flapper, 5520R Dial, 5305 2" Adapter, Screws , Spirotallic Gasket.
130055	5520-2 1/2 Complete *	2 1/2"	5520-2 1/2 Flapper, 5520R Dial, 5305 2" Adapter, Screws, Spirotallic Gasket.
130060	5520-3 Complete #	3"	5520-3 Flapper, 5520R Dial, 5305 2" Adapter, Screws, Spirotallic Gasket.

* Requires a 2 1/2" X 2" Hex Bushing.

Requires a 3" X 2" Hex Bushing.

Flow Indicator Parts	
Item Number	Part Number
130046	5520R Dial *
130065	5520-2 Flapper Only
130070	5520-2 1/2 Flapper Only
130075	5520-3 Flapper Only
130131	Sr. Spirotallic Gasket
130068	40-666 Screws
130045	5520T Dial *
118405	5305 2" MNPT X Sr. Head Adaptor

* Includes Dial, Bezel, Bracket & Screws.



130050

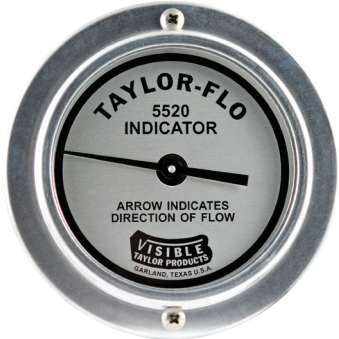

130046

Replacement Dial Ordering Information



Old Style Head

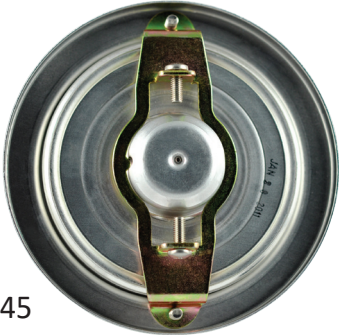

130045

Bracket mounts on top and is secured by two screws on the side of head.



New Style Head

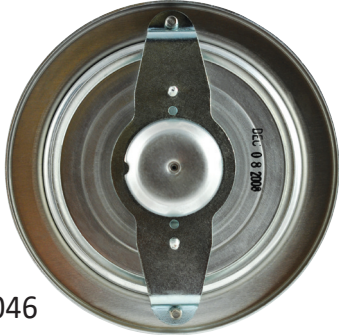

130046

Bracket mounts on top and is secured with dial screws.

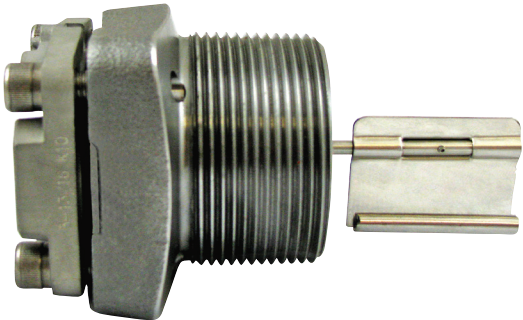

5520-2	L Dimension = 3 13/16"
5520-2 1/2	L Dimension = 5 5/16"
5520-3	L Dimension = 5 15/16"

L Dimension is the distance from gasket surface to the end of the flapper.

The RM Series RoadMaster gauges were designed to withstand the vibration and shock inherent in mobile service. Their service life in over-the-road, transports and bobtails, carrying liquids from LP-Gas to Anhydrous Ammonia(NH3), is unsurpassed. These gauges allow a continuous reading between 5% and 95% of tank contents.

The RM Series RoadMaster gauges are to be installed in the side or end of mobile tanks at the centerline. They are equipped with a spring controlled shock absorber on the float arm which substantially reduces the stress that quickly destroys conventional gauges. Angle mounting gauges are also available.

The standard model mounts in an 8 bolt adaptor and incorporates a 4" dial with an available 8" dial. When necessary, the dials are easily replaceable.

The RM Series RoadMaster gauges are designed for working pressures ranging from atmospheric to 450 psig.

Note: Refer to Gauge Instructions for mounting bolt torque specifications.

RoadMaster Standard Sizes				
Tank Diameter	With Fluorescent R3D Dial		With Standard Direct Read Dial	
	Item Number	Part Number	Item Number	Part Number
56"	131825	RM1425	131886	RM1425-003
66"	131830	RM2030	131885	RM2030-003
72"	131833	RM1833	131887	RM1833-003
74"	131834	RM1834	131721	RM1834-003
78"-79"	131836	RM1836	131837	RM1836-003
80"	131832	RM2437	131872	RM2437-003
82"	131838	RM2438	131878	RM2438-003
86"	131840	RM2440	131873	RM2440-003
88"	131841	RM1841	131881	RM1841-003
88"	131941	RM2941	131748	RM2941-003
90"	131842	RM2942	131876	RM2942-003
96"	131245	RM3245	131248	RM3245-003

RoadMaster Options	
Suffix	Description
None	With Fluorescent R3D Dial
-001	With Standard R3D Dial
-002	With Fluorescent Direct Read Dial
-003	With Standard Direct Read Dial
SS	Adds Stainless Steel Counter-Weight
X	Straddle Mount
Y	Includes Adapter To Fit A 2" Opening

Examples:

- RM1836 - A RM1836 with Fluorescent R3D Dial.
- RM1836-001 - A RM1836 with Standard R3D Dial.
- RM1836-002 - A RM1836 with Fluorescent Direct Read Dial.
- RM1836-003 - A RM1836 with Standard Direct Read Dial.
- RM1836SS - A RM1836 with all Stainless Steel Construction.
- RM1836X - A RM1836 for a Straddle Mount.
- RM1836Y - A RM1836 to fit a 2" Opening.

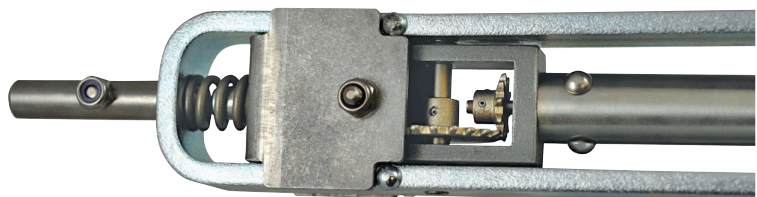

RoadMaster Parts

RoadMaster Parts		
Item Number	Part Number	Case Quantity
130040	Spirotallic Gasket – Standard	1 Pc.
118425	5331 - 2 1/2" X 8 Bolt Flange Adaptor	1 Pc.
118428	5330 Weld In 8-Bolt Flange Adaptor	1 Pc.
131812	Straddle Mount Adapter w/Screws & Gasket	1 Pc.
130093	Stud Bolt & Nut Kit	1 Pc.
131839	RoadMaster Dial & Bracket Kit - Complete	1 Pc.
131820	RoadMaster R3D Dial Only	1 Pc.
131821	RoadMaster Fluorescent Dial Only	1 Pc.
131822	RoadMaster R3D Fluorescent Dial Only	1 Pc.
131814	RoadMaster Illuminated MR Module *	1 Pc.
131845	RoadMaster Dial Bracket Kit	1 Pc.
131823	RoadMaster Angle Bracket Kit	1 Pc.
131824	RoadMaster Dial Crystal	1 Pc.
131819	RoadMaster Crystal Gasket	1 Pc.

* R3D Dial Sold Separately.

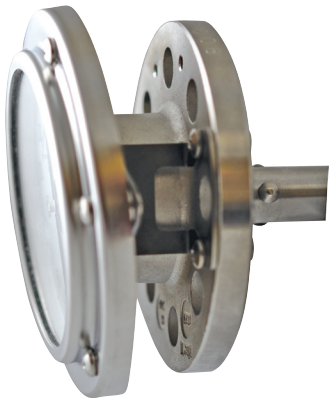

131823
Angle Bracket

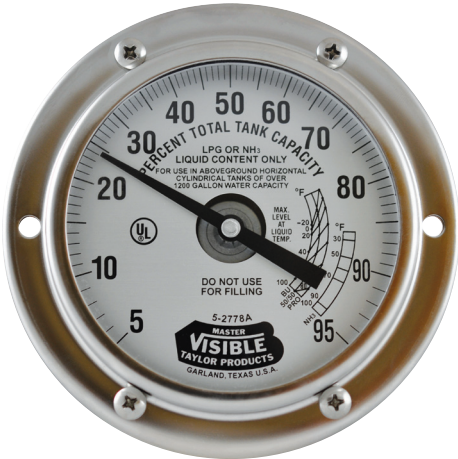

131839



131821

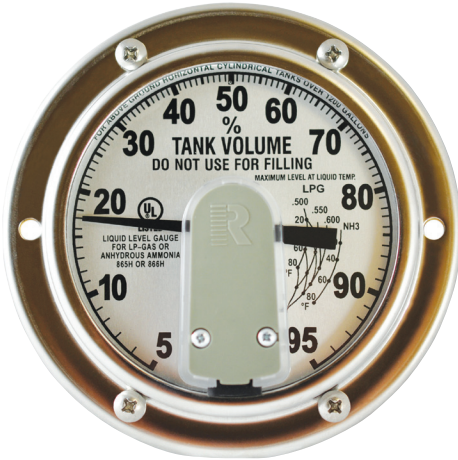

131820

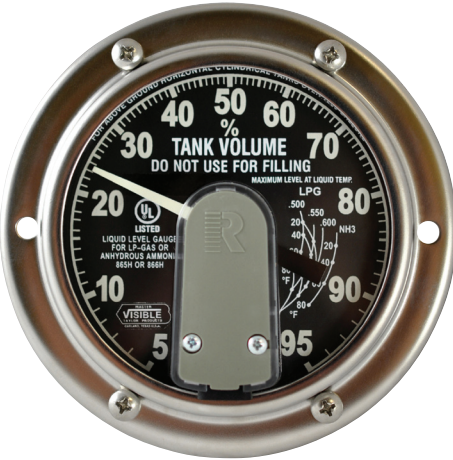

131822



131814

"We Specialize in Custom Size Gauges"

The Master Series™ liquid-level gauges are designed to indicate the liquid level contents of LP-Gas and Anhydrous Ammonia(NH3) in stationary-storage tanks.

The Master Series™ are available in two basic models:

Model A - Stainless Steel Senior head which mounts to a 2" MNPT x Senior adaptor.

Model B - Stainless Steel head which mounts to a 2 1/2" X 8-Bolt flange adaptor.

Both models incorporate a 8" dial with an available 4". When necessary, the dials are easily replaceable. Standard mounting is end or top mounting. These gauges can be special ordered with angle or straddle mounts. The model A comes standard with cap screws and a Senior spirothallic gasket. The model B comes standard with a stud & nut kit and spirothallic gasket.

The Master Series™ gauges are designed for working pressures ranging from atmospheric to 450 psig.

Note: Refer to Gauge Instructions for mounting bolt torque specifications.

Master Standard Sizes								
Item Number	Part Number	Tank Diameter	Tank Opening	Model Type	Mount	Case Quantity	Old LP-Gas Number	Old NH3 Number
138000	ME2434A	72"	2"	A	Side, End	1 Pc.	MD240A	DD240B
138005	ME2434B		2 1/2"	B	Side, End	1 Pc.	MD240B	DD240A
138010	ME2738A	82"	2"	A	Side, End	1 Pc.	MD270B	DD270D
138015	ME2738B		2 1/2"	B	Side, End	1 Pc.	MD270A	DD270G
138020	ME2839A	84"	2"	A	Side, End	1 Pc.	MD280B	DD280G
138025	ME2839B		2 1/2"	B	Side, End	1 Pc.	MD280C	DD280C
138030	ME3245A	96"	2"	A	Side, End	1 Pc.	MD320C	DD320F
138035	ME3245B		2 1/2"	B	Side, End	1 Pc.	MD320A	DD320B
138040	ME3650A	104"-108"	2"	A	Side, End	1 Pc.	MD360B	DD360A
138045	ME3650B		2 1/2"	B	Side, End	1 Pc.	MD360C	DD360B
138047	ME3854B	114"	2 1/2"	B	Side, End	1 Pc.	MD380D	DD380B
138050	ME3862A	130"	2"	A	Side, End	1 Pc.	ME430A	DD430B
138055	ME3862B		2 1/2"	B	Side, End	1 Pc.	MD380F	DD380F

Master Gauge Parts		
Item Number	Part Number	Model Type
130040	Spirothallic Gasket	B
118405	5305 2" MNPT X Sr. Head Adaptor	A
118425	5331 2 1/2" X 8 Bolt Flange Adaptor	B
118428	5330 Weld In 8 Bolt Flange Adaptor	B
130206	Master Gasket & Centralizer	B
131812	Straddle Mount Adapter w/Screws & Gasket	B

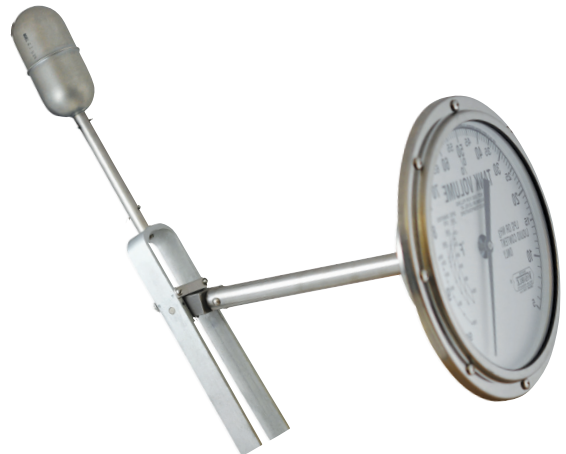

118428



118425



131812

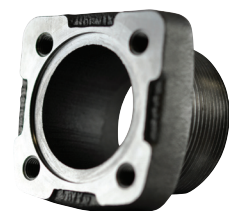

118405

Old Style Master Gauge Parts		
Item Number	Part Number	Model Type
130130	Sr. Teflon Gasket	A
130119	Sr. Gauge Screw *	A
130219	Master Gauge Bolts (8 Req.)	B
130036	4102 LP Only Dial 2-Bkt Pre 08	A & B
130030	4607 NH3 Only Dial 2-Bkt Pre 08	A & B
130035	Master Dial LP or NH3 2-Bkt Pre 08	A & B
130078	Master R3D Dial LP or NH3 2-Bkt Pre 08	A & B
130088	Master Fluorescent Dial LP & NH3 2-BKT	A & B
130094	Master R3D Fluorescent Dial LP & NH3 2-BKT	A & B
130107	Master Hall Effect Dial 2-BKT	A & B
130127	Master Dial Screws 1032-1 (2 Req.)	A & B
130205	Master Dial 2-Bkt Kit	A & B
130180	Master R3D Sender & Cable	A & B

* These screws come in packages of 50 Pcs.

New Style Master Gauge Parts		
Item Number	Part Number	Model Type
130131	Sr. Spirotallic Gasket – 4-Bolt	A
130145	Model A Gauge Screw	A
130095	Model A Head Strap Post 07	A
130097	Model A Master Dial LP or NH3 Post 07	A
130115	Model A Master R3D Dial Post 07	A
130203	Model A Float Bulb (70-102 Diameter) 2.5"	A
130208	Model A Float Bulb (103-130 Diameter) 3.5"	A
130040	Spirotallic Gasket – 8-Bolt	B
130093	Master Stud Bolt & Nut Kit (8)	B
130098	Master Dial 3-Bkt Kit	B
130090	Master Dial LP or NH3 3-Bkt Post 07	B
130091	4102 LP Only Dial 3-Bkt Post 07	B
130092	4607 NH3 Only Dial 3-Bkt Post 07	B
130034	Master R3D Dial LP or NH3 3-Bkt Post 07	B
130089	Master Fluorescent Dial LP & NH3 3-BKT	B
130099	Master R3D Fluorescent Dial LP & NH3 3-BKT	B
130204	Model B Float Bulb	B
130201	Master Glass Crystal & Gaskets -8"	A & B
130199	Master Lexan Crystal -8" *	A & B
130198	Gasket For Master Lexan Crystal -8" (2 Req.) *	A & B
130180	Master R3D Sender & Cable	A & B

* Must be ordered together.

Old Style Heads

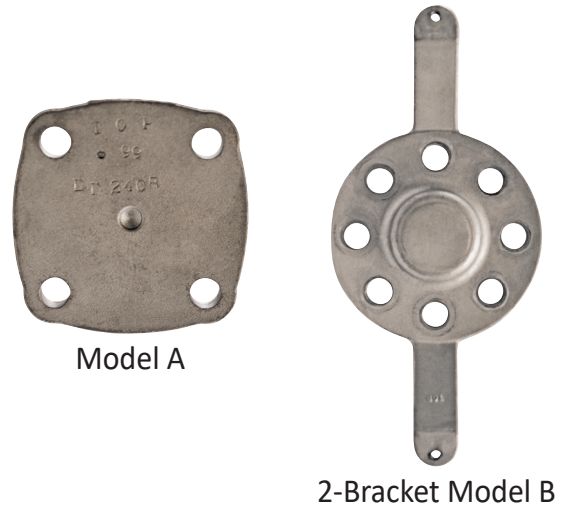

New Style Heads

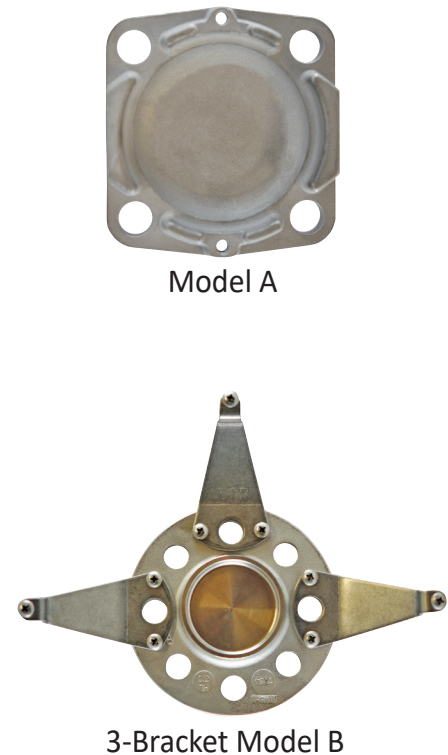

The Eliminator™ direct-reading float gauge is a direct replacement for 1" NPT rotary-type dip-tube gauges in LP-Gas and Anhydrous Ammonia(NH3) storage tanks. These Gauges are designed for larger tanks up to 96" in diameter. The Eliminator™ is not intended for use in filling tanks - its use is restricted to tanks with fixed liquid level gauges, used to determine when the maximum fill level has been reached. **Gauges for Tanks 85" & over are for LP-Gas Only!**

Eliminator Sizes

Item Number	Part Number	Tank Diameter
131898	EL4437	37"
131900	EL4442	42"
131901	EL6046	46"
131902	EL6048	48"
131904	EL6054	54"
131903	EL6056	56"
131906	EL6060	60"
131907	EL7262	62"
131908	EL7264	64"
131909	EL7266	66"
131911	EL7270	70"
131912	EL7272	72"
131914	EL8474	74"
131916	EL8476	76"
131931	EL8478	78"
131919	EL8479	79"
131920	EL8480	80"
131921	EL8481	81"
131922	EL8482	82"
131923	EL8484	84"
131925	EL8486 LP-Gas Only!	86"
131930	EL9696 LP-Gas Only!	96"

*** Any Eliminator installed in a mobile tank greater than 60" is excluded from the Taylor Gauge Limited Warranty and cannot be reworked.**



Eliminator Dials

Item Number	Part Number
130100	Eliminator Dial Assembly
130114	5-2870 Visible 4 R3D Dial Only
130160	Eliminator 8" Dial Kit
130180	Straight R3D Gen4 Module with 6' Cable



130100

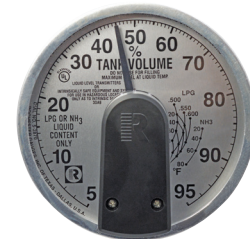

130114

How To Do The Conversion

1. After the storage tank has been evacuated, remove the rotary gauge from the 1" NPT opening at the centerline of the head. Clean and re-tap the female threads.
2. Remove the two screws from the bezel. Put the bezel, screws and dial chamber aside for the moment. Remove the four mounting screws holding the gauge head to the adapter.
3. Insert the lower portion of the replacement gauge, including the float bulb, float arm, gear housing and counterbalance, into the tank opening.
4. Apply three wraps of 1/2" wide Teflon tape, or other suitable thread sealant, to the 1" NPT threads on the steel adapter through which the gauge support passes.
5. Screw the adapter into the tank opening to achieve a leak-tight joint, and align the gauge mounting holes in the horizontal plane.
6. Using the gasket and four mounting screws supplied, attach the gauge to the adapter finger tight. Be sure the gauge is right side up, the bracket tab for locating dial chamber should be on the right. **Torque the mounting screws evenly to 140/150 In/Lbs. using a cross pattern.**
7. Reattach the 4" dial chamber and bezel to the Senior™ gauge head brackets using the two screws supplied.
8. If you end up with the dial chamber upside down, you cannot solve the problem by rotating the bracket. You must rotate the entire gauge 180°.

Rotary Gauges

Fisher™ brand rotary gauges can be used on stationary or mobile tanks to visually indicate the amount of LP- Gas or Anhydrous Ammonia (NH3) in the container. They are also used in filling the tank to the proper liquid level. On mobile applications and some large stationary storage tanks, hangers are recommended to support the horizontal length of the dip tube.

The Gauge is operated by opening the small bleed orifice when the tube is in the vapor space of the tank. Moving the pointer on the dial causes the end of the tube to move until it contacts liquid in the container. At that point, discharge from the bleed orifice turns from vapor to liquid & the rotary gauge dial gives the volume percentage of liquid in the tank.

J31 Series - Consists of heavy duty gauges that minimize vibration effects (swaying, bouncing) by a long (68-inches) stem tube extension. Gauges fit 1-inch female coupling container connections.

All gauges have stem and dip tubes with an extra large inside diameter. This assures that the correct liquid level can be obtained quickly.

A nylon (PA) packing sleeve and a friction ring for the pointer indicator gives smooth rotation and long service life. Steel & stainless steel materials resist rust or corrosion. Standard product temperature rating is -20° to 160°F.

NH3 Rotary Gauges		
Item Number	Part Number	Length
121120	J31LA-1	68"
121125	J31LA-2	69" - 92"
121130	J31LA-3	93" - 108"
121135	J31LA-3L	109" - 140"

Each Gauge Must Be Bent Before Installation.

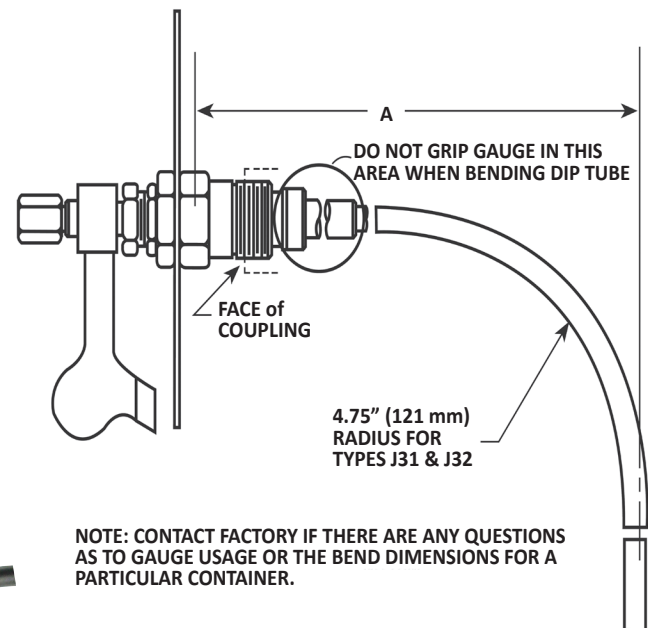

NOTE: CONTACT FACTORY IF THERE ARE ANY QUESTIONS AS TO GAUGE USAGE OR THE BEND DIMENSIONS FOR A PARTICULAR CONTAINER.

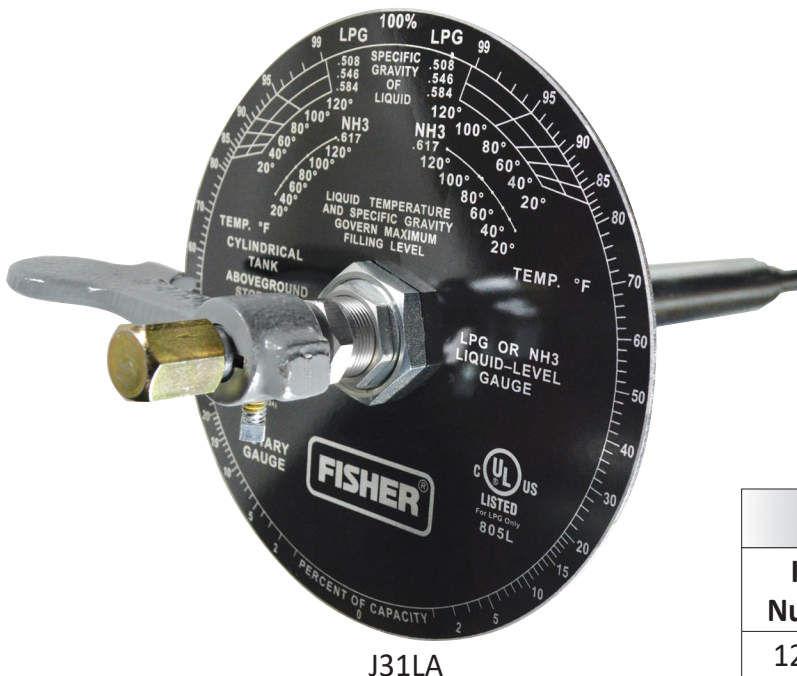

J31LA

Shipping Notice:

The J31LA-1 & J31LA-2 ship UPS.

The J31LA-3 & J31LA-3L will be shipped via motor freight.

The J31LA-3 if shipped UPS gets an additional oversize charge.

Rotary Gauge Parts		
Item Number	Part Number	Description
122917	P323/P324	LPG/NH3 Dial
128217	T10971000A2	Cap & Disc Assy.
128139	T1088719232	Dial Indicator
128209	T1096424152	Indicator Set Screw

The 94442A Stationary Tank Monitor (STM) is used for measuring LPG level in a tank. It can be installed indoors or outdoors at a convenient location that can be up to 300 feet from the tank. A level sender is also included which must be installed in the float gauge located on the tank. The LPG tank does not have to be emptied or purged to install the sender. Its' universal design fits any gauge that has an R3D dial which allows you to check the LPG level at the tank.

Monitors 2 LPG Tank Levels (Sensor for second tank optional).

State-of-the-art intelligent microprocessor based electronics.

Hi/Lo alarm set points programmable using built-in pushbuttons.

Analog Output for each channel, 0-5 VDC standard, 4-20 mA optional.

RS232 Serial Interface for direct connection to PC/RTU or PLC.

NEMA 4 enclosure suitable for outdoor use.

One LPG sensor included to fit float gauge with Junior tabbed dial.

Will work with any gauge that has an R3D dial installed.

Large LCD readout indicating Level, Low Set Point and High set Point for each channel.

One Form "C" (NC-C-NO) contact available for each channel. Contact rating 120 VAC @ 3 Amps.

Operates on 12 to 24 VDC power and a 120 VAC wall transformer is included for AC operation.



136619

Stationary Tank Monitor & Cables

Item Number	Part Number	Description	Case Quantity
136619	S T M 94442A	Includes Monitor, R3D Dial w/ Sender, & AC Adapter	1 Pc.
136626	ST-STMISO420	Includes Monitor, R3D Dial w/ Sender, AC Adapter, 4-20ma Transmitter	1 Pc.
136125	SIG420	STM 4-20mA Signal Conditional For R6315-12 (Tank To 136619)	1 Pc.
136130	ISO420-1	STM 4-20mA Signal Isolator For R6315-12 (136619 To PLC)	1 Pc.
136135	STM-48V	STM -48V Power Supply Adapter	1 Pc.
136603	HE-2 Kit	3 To 2 Wire For Analog 136619	1 Pc.

HE-2 Conversion Kit



Old Style STM Obsolete

The 0-1000 Ohm 2-Wire Sender is obsolete for the old style 136619 (shown at left). If your 0-1000 dial fails you can still use the monitor with the HE-2 Kit upgrade. All you need is the HE-2 Kit and an R3D dial installed in your existing float gauge.

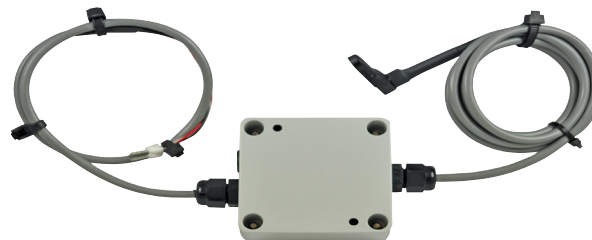

3 To 2 Wire for Analog 136619

Monitor Parts

R3D Gen4 Modules				
Item Number	Part Number	Description	Fits	Case Quantity
130170	9704-RD106M	Angled R3D Gen4 Module with 6' Cable	Gen4 R3D Dials (White Tabbed)	1 Pc.
130180	9704-SM106M	Straight R3D Gen4 Module with 6' Cable		1 Pc.



130170



130180

Reed Switches			
Item Number	Part Number	Description	Case Quantity
130110	9750-05	15-25% Switch	1 Pc.
130111	9750-07	25-30% Switch	1 Pc.



130111

Sender			
Item Number	Part Number	Description	Case Quantity
136530	P2537	0-90 Ohms Sender	1 Pc.

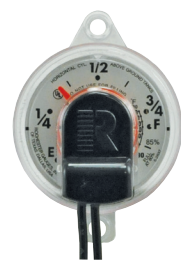

136530

Storage Tank Monitor Parts				
Item Number	Part Number	Description	Fits	Case Quantity
136120	R6315-12	4-20 mA Liquid-Level Transmitter	Master & RoadMaster R3D Dials	1 Pc.
136121	146S-1	Intrinsic Safety Barrier	For R6315-12	1 Pc.
130180	9704-SM106M	Master R3D Sender & Cable	Master & RoadMaster R3D Dials	1 Pc.



130180



R6315-12

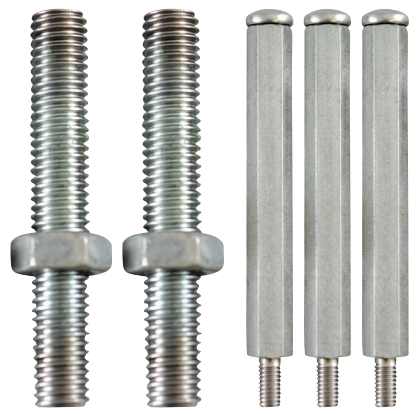

Above Ground LP Dials					
Item Number	Part Number	Type	Guide Hole	Graduations	Same As
130012	2701 CV LP Dial	Jr. or Sr. Drop-In	@ 94%	5% - 94%	130022
130022	2701 R3D LP Dial	Jr. or Sr. Drop-In	@ 5%	5% - 94%	130012
130009	2701 CV LP Dial	Jr. or Sr. Drop-In	@ 5%	5% - 94%	130023
130023	2701 R3D LP Dial	Jr. or Sr. Drop-In	@ 30%	5% - 94%	130009
130021	2701 CV LP Dial	Jr. Tabbed	N/A	5% - 94%	130082
130082	2701 R3D LP Dial	Jr. Tabbed	N/A	5% - 94%	130021
130037	2201 CV LP Dial	Sr. Tabbed	N/A	5% - 94%	403594
403594	2701 R3D LP Dial	Sr. Tabbed	N/A	5% - 94%	130037
130058	2701 R3D LP Dial	Snap-On	N/A	5% - 94%	N/A

Jr. or Sr. Drop-In



130012

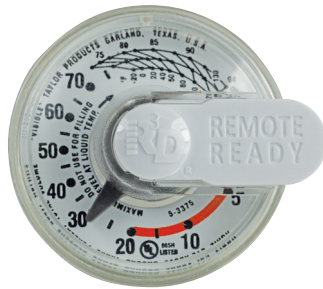

130022

Jr. Tabbed



130021

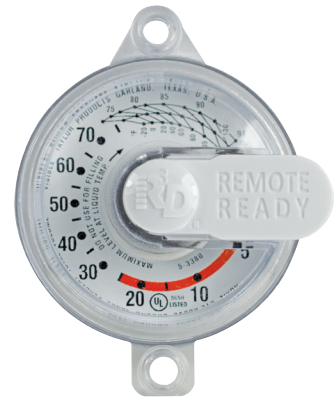

130082

Jr. or Sr. Drop-In



130009

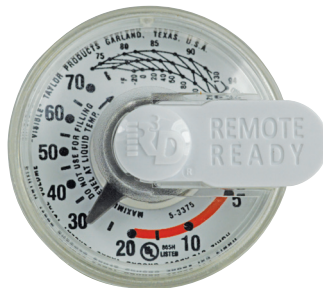

130023

Sr. Tabbed



130037



403594

Snap-On



130058

Below Ground & Motor Fuel LP Dials

Below Ground LP Dials					
Item Number	Part Number	Type	Guide Hole	Graduations	Same As
130011	2700 CV LP Dial	Jr. or Sr. Drop-In	@ 94%	5% - 94%	130044
130044	2700 R3D LP Dial	Jr. or Sr. Drop-In	@ 5%	5% - 94%	130011
130026	2700 CV LP Dial	Jr. or Sr. Drop-In	@ 5%	5% - 94%	130028
130028	2700 R3D LP Dial	Jr. or Sr. Drop-In	@ 30%	5% - 94%	130026
130083	2700 R3D LP Dial	Jr. Tabbed	N/A	5% - 94%	N/A

Jr. or Sr. Drop-In

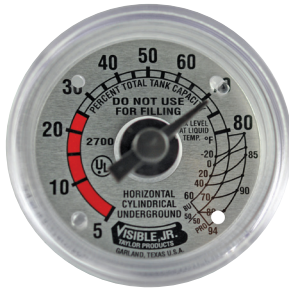

130011



130044

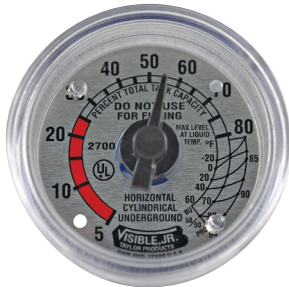

130026



130028

Jr. Tabbed

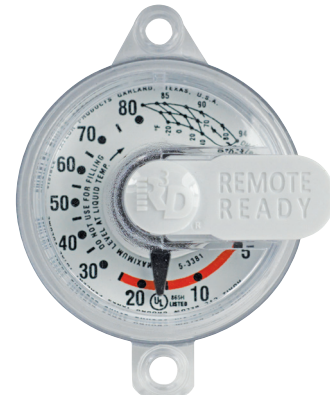

130083

Motor Fuel LP Dials				
Item Number	Part Number	Type	Guide Hole	Graduations
136000	CV50 LP Dial	Jr. or Sr. Drop-In	@ LP	Fractional E-3/4
136005	CV50 LP Dial	Jr. Tabbed	N/A	Fractional E-3/4

Jr. or Sr. Direct Read



136000

Jr. Tabbed



136005

Lift Truck LP Dials				
Item Number	Part Number	Type	Guide Hole	Graduations
130013	2733U CV LP Dial 33 1/2#	Jr. or Sr. Drop-In	@ 7%	H = 13-40% V = 7-20%
130033	7533U CV LP Dial 33 1/2#	Jr. or Sr. Drop-In	@ 13%	V = 5-20% H = 13-40%
130081	2733U-P LP Dial 33 1/2#	Jr. Tabbed	N/A	V = 7-20% H = 13-40%
403582	33 1/2# LP Dial	Snap-On	N/A	V = 7-20% H = 13-40%
130042	2766 CV LP Dial 40#	Jr. or Sr. Drop-In	@ 60%	5% - 60%
130017	2710 CV LP Dial 43 1/2#	Jr. or Sr. Drop-In	@ 35%	8% - 35%
130027	2710 CV LP Dial 43 1/2#	Jr. or Sr. Drop-In	@ 8%	8% - 35%
130048	2743U LP Dial	Jr. Tabbed	N/A	H = 12-43% V = 10-23%
130051	43 1/2# LP Dial	Jr. Tabbed	N/A	V = 7-17% H = 13-40%
130043	E - F LP Dial	Jr. Tabbed	N/A	Fractional E - F
130052	E - F LP Dial	Jr. Tabbed	N/A	Fractional E - F
130057	E - F LP Dial	Jr. Tabbed	N/A	V = OK-OK H = E-F

Jr. Tabbed



130081

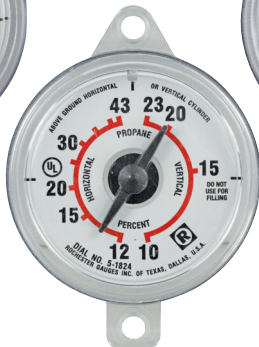

130048



130051

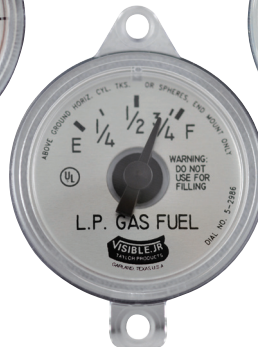

130043

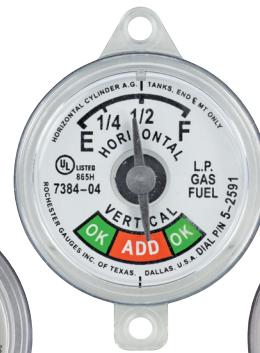

130057

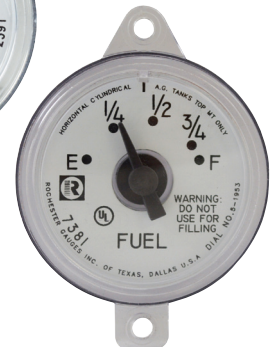

130052

Jr. or Sr. Drop-In



130013

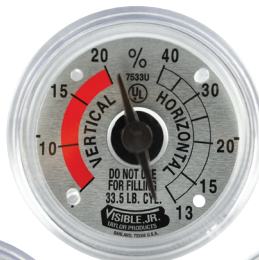

130033

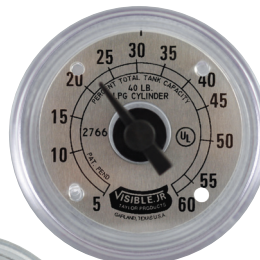

130042

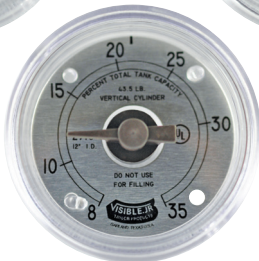

130017



130027

Snap-On



403582

Vertical Cylinder LP Dials

Vertical Cylinder LP Dials					
Item Number	Part Number	Type	Guide Hole	Graduations	Same As
130006	2722 CV LP Dial - 200#	Jr. or Sr. Drop-In	@ 85%	5% - 85%	130039
130007	2722 CV LP Dial - 200#	Jr. or Sr. Drop-In	@ 5%	5% - 85%	N/A
130039	2722 R3D LP Dial - 200#	Jr. or Sr. Drop-In	@ 10%	5% - 85%	130007
130038	2722 R3D LP Dial - 200#	Jr. Tabbed	N/A	5% - 85%	N/A
130014	2765 CV LP Dial - 420#	Jr. or Sr. Drop-In	@ 80%	10% - 80%	132765
132765	2765 R3D LP Dial - 420#	Jr. or Sr. Drop-In	@ 15%	10% - 80%	130014
130056	2765 R3D LP Dial - 420#	Snap-On	N/A	10% - 80%	N/A
130084	2765 R3D LP Dial - 420#	Jr. Tabbed	N/A	10% - 80%	N/A
130019	2721 CV LP Dial - 420#	Jr. or Sr. Drop-In	@ 12%	12% - 85%	N/A
130008	2746 CV LP Dial	Jr. or Sr. Drop-In	@ 10%	8% - 68%	N/A

Jr. or Sr. Drop-In

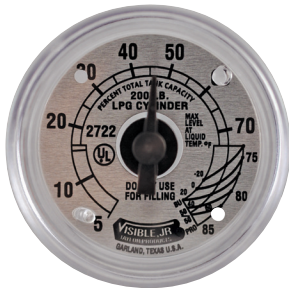

130006

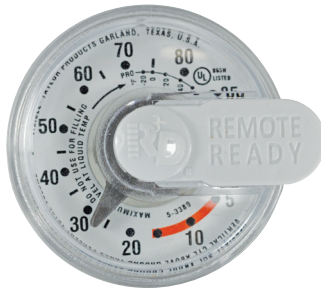

130039

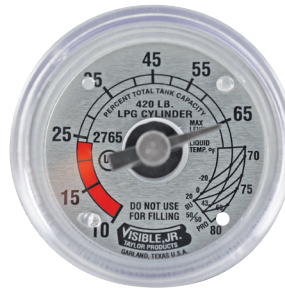

130014



132765



130007



130019



130008

Jr. Tabbed



130038



130084

Snap-On

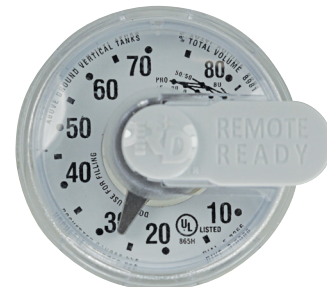

130056

"We Specialize in Custom Size Gauges"

Glue-On ViSible 2" LP Dials

Item Number	Part Number	Type	Graduations
130005	2201 LP Dial	Jr. Above Ground Glue-On	5% - 94%
130148	2701 R3D LP Dial	Jr. Above Ground Glue-On	5% - 94%
130149	2700 R3D LP Dial	Jr. Below Ground Glue-On	5% - 94%
130010	2201 LP Dial	Sr. Above Ground Glue-On	5% - 94%
130053	2201 R3D LP Dial	Sr. Above Ground Glue-On	5% - 94%

Jr. Glue-On

Sr. Glue-On

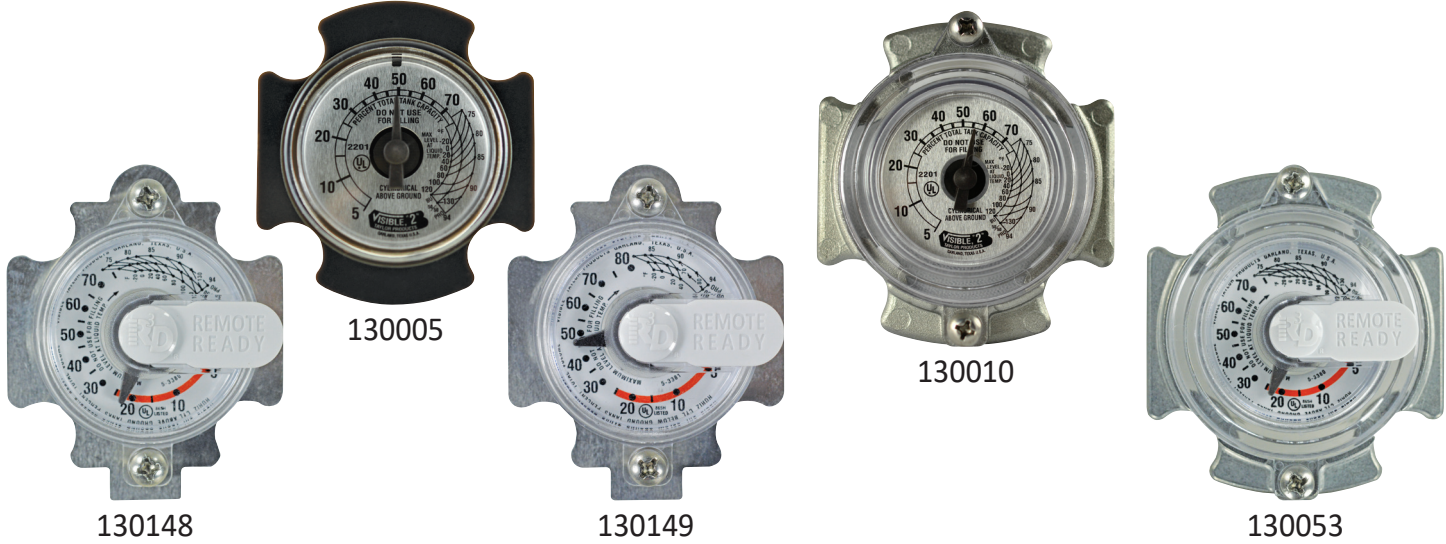

ViSible 4" & Master 8" LP Dials

Item Number	Part Number	Type	Graduations	Fits
130020	5511T LP Dial	ViSible 4"	5% - 95%	Old Style Sr. Head
130085	5511R LP Dial	ViSible 4"	5% - 95%	New Style Sr. Head
130036	4102 LP Dial	Master Dial - 2 Bracket	5% - 95%	Old Style Master
130091	4102 LP Dial	Master Dial - 3 Bracket	5% - 95%	New Style Master

ViSible 4" - Old Style

Master 8" - Old Style



NH3 Dials				
Item Number	Part Number	Type	Guide Hole	Graduations
130018	2208 CV NH3 Dial	Jr. or Sr. Drop-In	@ 93%	5% - 95%
130029	2208 CV NH3 Dial	Jr. or Sr. Drop-In	@ 5%	5% - 95%
130049	2208 NH3 Dial	Jr. Tabbed	N/A	5% - 95%
130041	2209 NH3 Dial	Sr. Tabbed	N/A	5% - 95%
130016	2208 NH3 Dial	Jr. Universal Glue-On	N/A	5% - 95%
130015	2208 NH3 Dial	Sr. Universal Glue-On	N/A	5% - 95%
130025	5553T NH3 Dial	ViSible 4" - Old Style Taylor	N/A	5% - 95%
130086	5553R NH3 Dial	ViSible 4" - New Style Rochester	N/A	5% - 95%
130030	4607 Master Dial	4607 Master 8" Dial - 2 Bracket	N/A	5% - 95%
130092	4607 Master Dial	4607 Master 8" Dial - 3 Bracket	N/A	5% - 95%

Jr. or Sr. Drop-In



130018

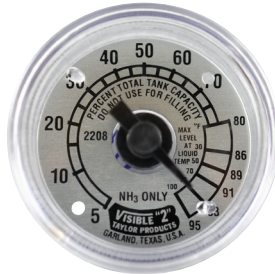

130029

ViSible 4" - Old Style



130086

ViSible 4" - New Style



130025

Jr. Tabbed

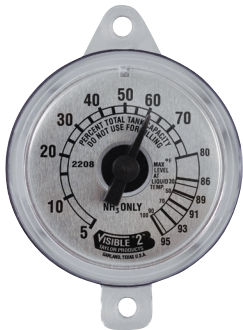

130049

Sr. Tabbed

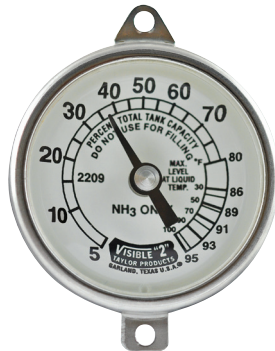

130041

Master 8" - 2 Bracket



130030

Master 8" - 3 Bracket



130092

Jr. Glue-On

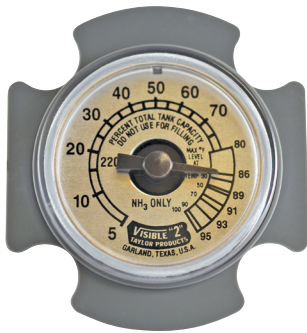

130016

Sr. Glue-On

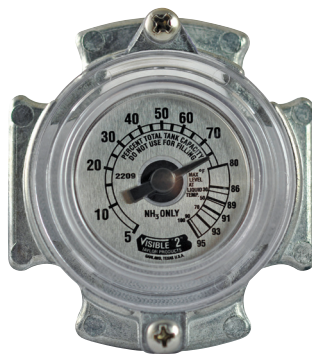

130015

ViSible 4" Combination LP & NH3 Dials

Item Number	Part Number	Type	Graduations	Fits
130087	2778R	ViSible 4"	5% - 95%	New Style Sr. Head
130045	5520T	ViSible 4"	Arrow Indicates Direction of Flow	Old Style Sr. Head
130046	5520R	ViSible 4"		New Style Sr. Head

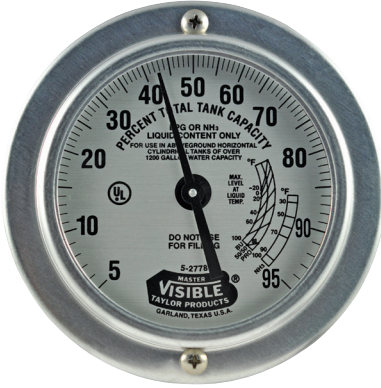

130087

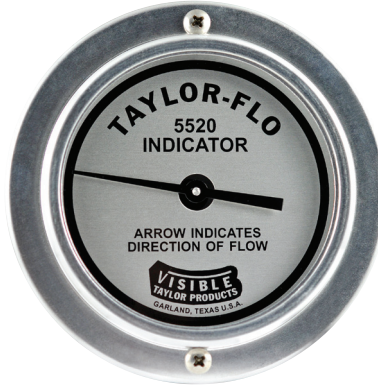

130045



130046

RoadMaster 4" Combination LP & NH3 Dials

Item Number	Part Number	Type	Graduations	Fits
131839	RoadMaster 4" Dial	Dial & Bracket Assembly	5% - 95%	RoadMaster
131820	RoadMaster 4" R3D Dial	Dial Only	5% - 95%	RoadMaster
131821	RoadMaster 4" Fluorescent Dial	Dial Only	5% - 95%	RoadMaster
131822	RoadMaster 4" Fluorescent R3D Dial	Dial Only	5% - 95%	RoadMaster
131814	RoadMaster 4" Illuminated ME Module	Module Kit *	5% - 95%	RoadMaster

* R3D Dial Sold Separately.



131839

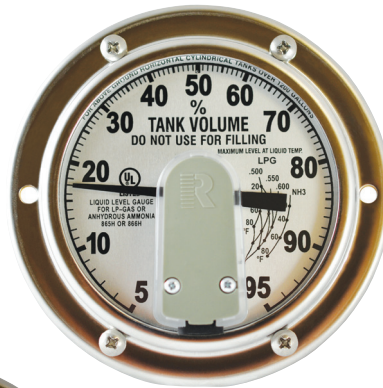

131820



131821



131822



131814

Combination LP & NH3 Master 8" Dials

Master 8" 2-Bracket Combination LP & NH3 Dials				
Item Number	Part Number	Service	Graduations	Fits
130035	Master Dial - 2 Bracket	LP-Gas or NH3	5% - 95%	Old Style Taylor Model A & Model B Master Gauges
130078	Master R3D Dial - 2 Bracket	LP-Gas or NH3	5% - 95%	
130088	Master Fluorescent Dial - 2 Bracket	LP-Gas or NH3	5% - 95%	
130094	Master Fluorescent R3D Dial - 2 Bracket	LP-Gas or NH3	5% - 95%	

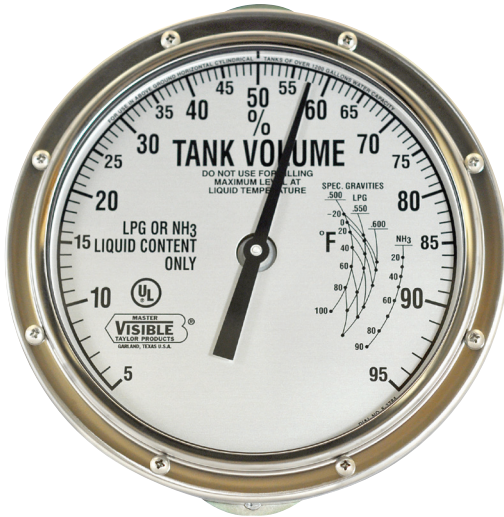

130035

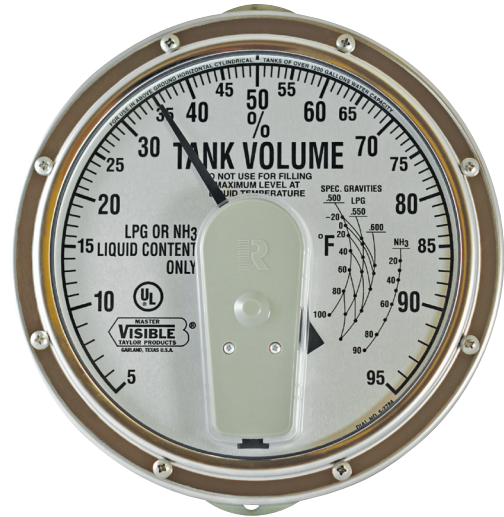

130078



130088



130094

Master 8" 3-Bracket Combination LP & NH3 Dials

Item Number	Part Number	Service	Graduations	Fits
130090	Master Dial - 3 Bracket	LP-Gas or NH3	5% - 95%	New Style Rochester Model B Master Gauges
130034	Master R3D Dial - 3 Bracket	LP-Gas or NH3	5% - 95%	
130089	Master Fluorescent Dial - 3 Bracket	LP-Gas or NH3	5% - 95%	
130099	Master Fluorescent R3D Dial - 3 Bracket	LP-Gas or NH3	5% - 95%	
130097	Master Dial	LP-Gas or NH3	5% - 95%	New Style Model A
130115	Master R3D Dial	LP-Gas or NH3	5% - 95%	

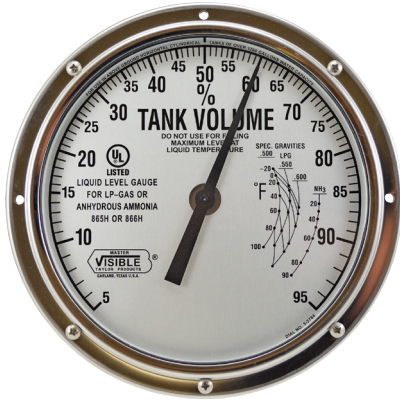

130090



130034

*Mounting Holes For
Model B Dials
are @ 9 O'Clock,
12 O'Clock, & 3 O'Clock.*



130089



130099



130097



130115

*Mounting Holes For
Model A Dials are @
12 O'Clock & 6 O'Clock.*

Dial Brackets, Dial Screws, & Broken Screw Kit

Glue-On Dial Brackets		
Item Number	Part Number	Description
130138	JR-GLUBRK	Jr. Glue-On Dial Brakcet
130139	SR-GLUBRK	Sr. Glue-On Dial Brakcet

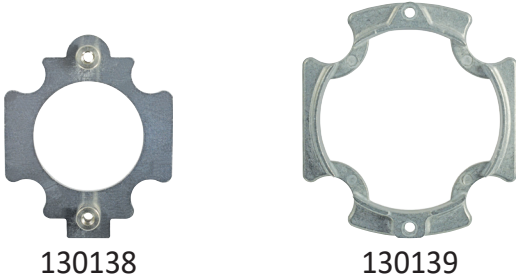

Dial Screws		
Item Number	Part Number	Fits
130140	40-416	Dials w/Tabs
130150	40-778	Large Screw For Brass Heads
130151	40-750	Small Screw For Aluminum Heads
130383	40-413	Screws For 4" & 8" Dials

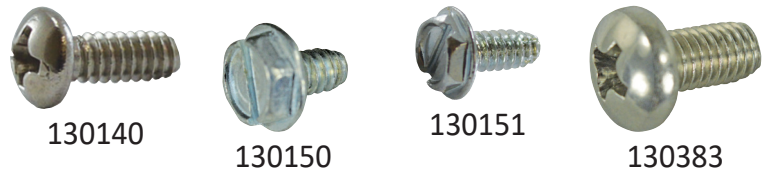

ViSible 4 Dial Brackets & Parts		
Item Number	Part Number	Description
130380	Taylor Dial Bracket	4" Dial Brakcet w/Screws for Taylor Sr. Head
130381	Rochester Dial Bracket	4" Dial Brakcet w/Screws for Rochester Sr. Head
130383	40-413	Dial Screws
130385	39-2	4" Dial Bezel



Broken Screw Kit		
Item Number	Part Number	Description
130054	Jr. & Sr. Broken Screw Kit	Includes Blocks, Bolts, Drills, Taps & Instructions

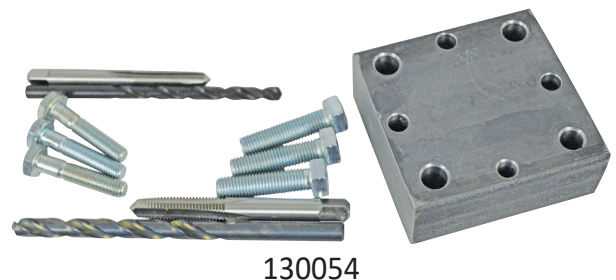

Order by Gauge Code - Stamped on the Head of any Gauge

Simply order Taylor ViSible Gauges by the Gauge Code, and an exact duplicate of the gauge from which the code was taken will be delivered. All Junior and Senior Gauges produced since 1964 have the Taylor code stamped on the top of the head. For all Gauges produced since 2008 the sides of the heads are stamped. For other gauges, and pressure vessel gauge needs, see below.

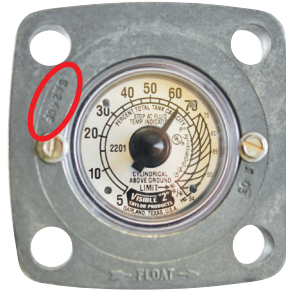

Old Style.



New Style.

Notes where Gauge Code is located.

If Above Code is Not Available, Specify:

1. TYPE OF SERVICE - LP-Gas or Anhydrous Ammonia(NH3).
2. GAUGE SIZE (or Head Type) - Specify Junior Size, Senior Size, ViSible 4", 3/4" Threaded, 1" Threaded, 1 1/4" Threaded, RoadMaster, or Master Gauge Model (4 Bolt or 8 Bolt).

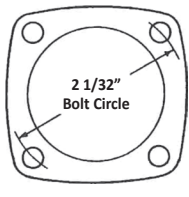

JR. Head

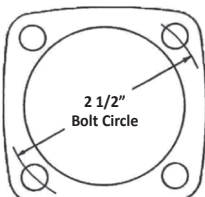

SR. Head

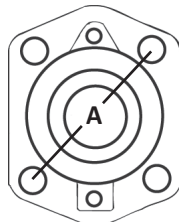

JR. Head
A = 2 1/32"

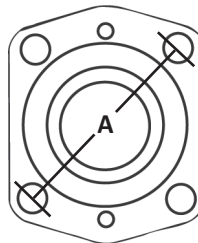

SR. Head
A = 2 1/2"

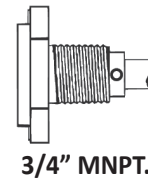

3/4" MNPT.

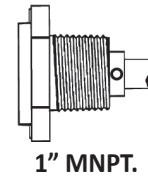

1" MNPT.

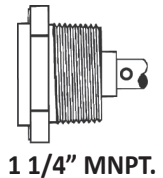

1 1/4" MNPT.

3. TYPE MOUNTING - Top, Side, End, or Angle (if angle, specify angle above horizontal center line).

Mounting Location

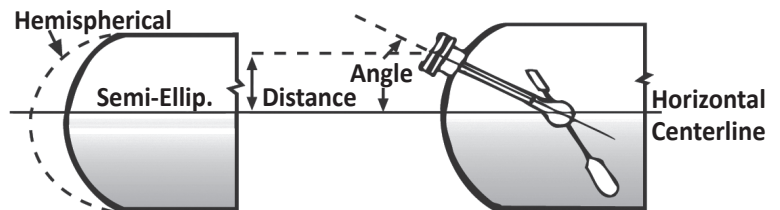
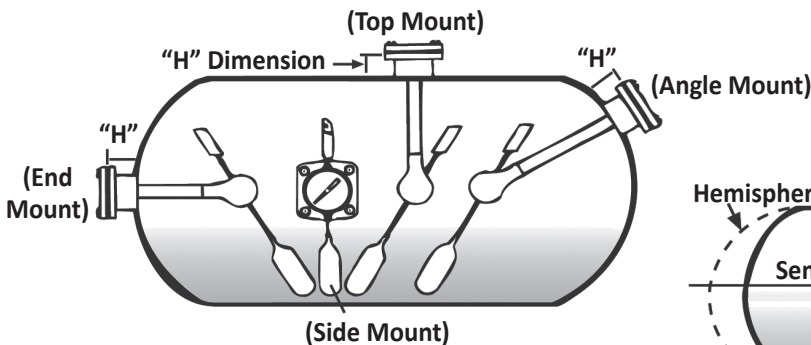

4. GIVE FOLLOWING DIMENSIONS:

H = Distance from tank surface to gasket surface.
D = Inside diameter of tank or cylinder.

5. FOR VERTICAL CYLINDERS ONLY:

X = Distance from center of adaptor to nearest inside wall.
O = Cylinder height.
H = Distance from tank surface to gasket surface.

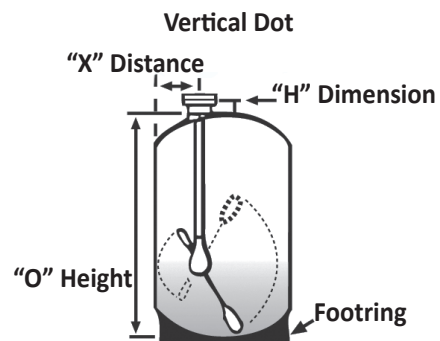

Gauge Reference Information

NH3 Tanks	
Prefix	Gauge Description
AA	Sr. NH3 Top Mount
AB	Sr. NH3 Below Mount
AC	Sr. NH3 Angle Mount
AD	Sr. NH3 End Mount
BA	Jr. NH3 Top Mount
BB	Jr. NH3 Below Mount
BC	Jr. NH3 Angle Mount
BD	Jr. NH3 End Mount
CA	Sr. NH3 ViSible 4" Top Mount
CB	Sr. NH3 ViSible 4" Below Mount
CC	Sr. NH3 ViSible 4" Angle Mount
CD	Sr. NH3 ViSible 4" End Mount

LP Tanks	
Prefix	Gauge Description
HA	1" Brass LP Top Mount
HC	1" Brass LP Angle Mount
HD	1" Brass LP End Mount
JA	Jr. LP Top Mount
JB	Jr. LP Below Mount
JC	Jr. LP Angle Mount
JD	Jr. LP End Mount
JU	Jr. Universal Mount
SA	Sr. LP Top Mount
SB	Sr. LP Below Mount
SC	Sr. LP Angle Mount
SD	Sr. LP End Mount
TA	1 1/4" Brass Top Mount
TC	1 1/4" Brass Angle Mount
TD	1 1/4" Brass End Mount
TU	1 1/4" Brass Universal Mount
UA	3/4" Brass Top Mount
UD	3/4" Brass End Mount
UU	3/4" Snap-On Universal Mount
UU	3/4" Zinc Universal Mount
VA	Sr. LP ViSible 4" Top Mount
VB	Sr. LP ViSible 4" Below Mount
VC	Sr. LP ViSible 4" Angle Mount
VD	Sr. LP ViSible 4" End Mount

LP or NH3 Mobile & Storage	
Prefix	Gauge Description
EL	1" Eliminator End Mount
DA	Master NH3 Top Mount are Obsolete Use MT
DD	Master NH3 End Mount are Obsolete Use ME
MA	Master LP Top Mount are Obsolete Use MT
MD	Master LP End Mount are Obsolete Use ME
ME	Master LP or NH3 End Mount
MT	Master LP or NH3 Top Mount
RM	RoadMaster End Mount

Motor Fuel Tanks	
Suffix	Gauge Description
__A	Recessed (-3/8") Upper 45° Angle Mount With Direct Reading Dial
__AB	Recessed (-3/8") Lower 45° Angle Mount With Direct Reading Dial
__ABC	Recessed (-3/8") Lower 45° Angle Mount With Converta-ViSible Dial
__ABN	Non-Recessed (+5/16") Lower 45° Angle Mount With Direct Reading Dial
__ABNC	Non-Recessed (+5/16") Lower 45° Angle Mount With Converta-ViSible Dial
__AC	Recessed (-3/8") Upper 45° Angle Mount With Converta-ViSible Dial
__AN	Non-Recessed (+5/16") Upper 45° Angle Mount With Direct Reading Dial
__C	End Mount With Direct Reading Dial
__CC	End Mount With Converta-ViSible Dial
__L	Recessed (-3/8") Lower 45° Angle Mount With Direct Reading Dial
__LN	Non-Recessed (+5/16") Lower 45° Angle Mount With Converta-ViSible Dial
__T	Recessed (-3/8") Top Mount With Direct Reading Dial
__TC	Recessed (-3/8") Top Mount With Converta-ViSible Dial
__TN	Non-Recessed (+5/16") Top Mount With Direct Reading Dial

ViSible 2" Dials

The ViSible 2" dials come in a variety of styles and sizes. The Direct Read dials are available in Drop-In, Jr. Tabbed, Sr. Tabbed, and Glue-On Replacement (Jr. & Sr.). The Gen4 R3D Dials are Hall Effect compatible and are available in Drop-In, Jr. Tabbed and Sr. Tabbed. **Note:** *The Drop-In dials fit Jr. & Sr. Old Style heads and have locating tabs on the back of the dial that position the dial in the head of the gauge. Glue-On Replacement dials will work with any Jr. or Sr. gauge ever built.*



Drop-In

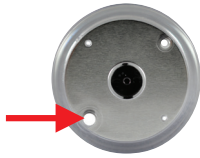

Style A

The large hole on the back lines up with the 94% mark on the front of the dial.



R3D Drop-In



Style B

The large hole on the back lines up with the 5% mark on the front of the dial.

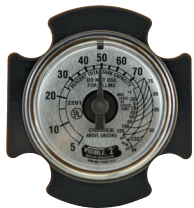

Jr. Glue-On

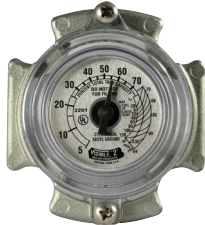

Sr. Glue-On

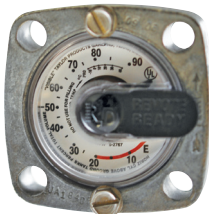

Old Style Jr.

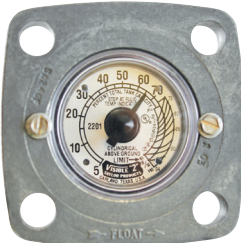

Old Style Sr.



Jr. Tabbed



Sr. Tabbed



R3D Jr. Tabbed



R3D Sr. Tabbed



Jr. Glue-On

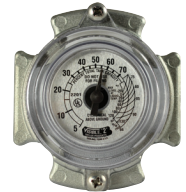

Sr. Glue-On



New Style Jr.

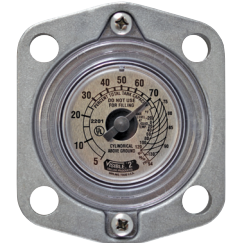

New Style Sr.

ViSible 4" Dials

The ViSible 4" dials come in two styles. If you have the Old Style Head then you need a dial with the "T" suffix. If you have the New Style Head then you need a dial with the "R" suffix.

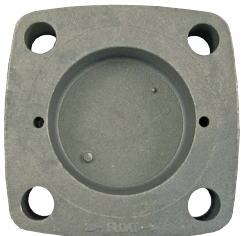

"T" Old Style Head

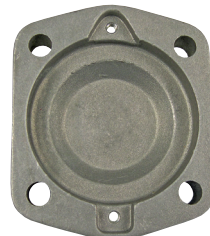
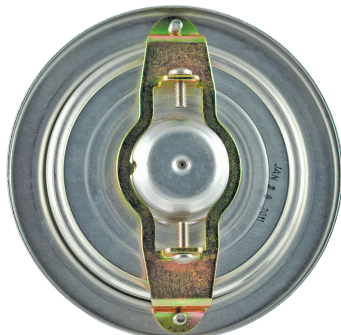

"R" New Style Head



The following dials are available for the Old Style Head.
5520T, 5511T, and 5553T

The following dials are available for the New Style Head.
5520R, 5511R, 5553R, and 2778R

Dial Ordering Information

Master 8" Dials

The dials for the Master Gauges are different according to when they were manufactured. The Old (Taylor) Style heads were made Pre 2008 & are referred to as 2-Bracket. The same 2-Bkt dial will work with both the Model A & Model B Old Style Heads. The New (Rochester) Style heads were made Post 2007 & are different for the Model A & B. The Dials for the Model A have holes @ 12 & 6 o'clock to mount the dial. The Dials for the Model B have holes @ 9, 12 & 3 o'clock to mount the dial & are referred to as 3-Bracket.



Old Style Head

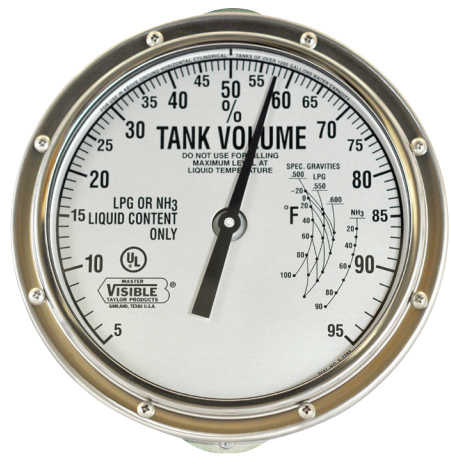

2-Bracket Style Dial



New Style Model A Head

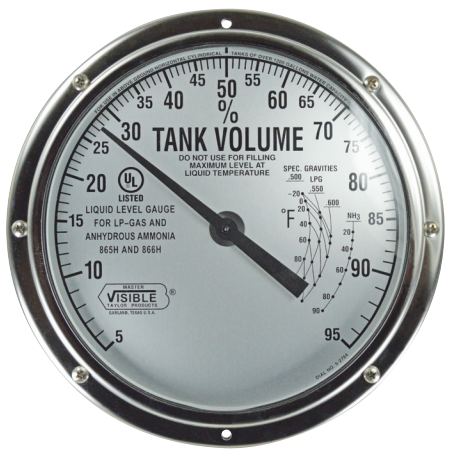

New Style Model A Dial

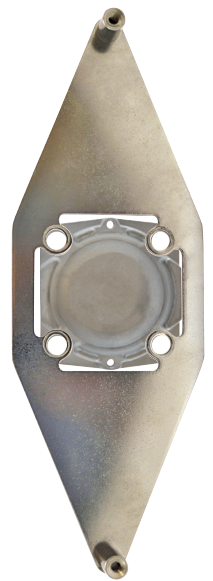

New Style Model A Head With Headstrap



3-Bracket Style Head New Model B

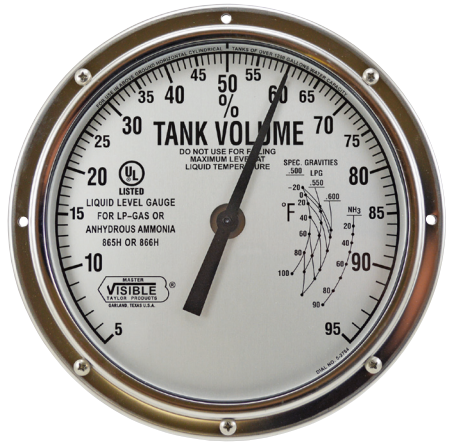

3-Bracket Style Dial New Model B

Jr. & Sr. Glue-On Dial Instructions *

1. Determine dial orientation.
2. Break out lens, remove pointer, and bend over stem.
3. Glue on the new dial.

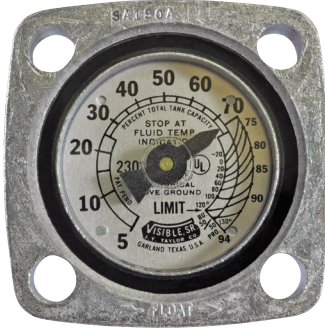

1. Before Installation

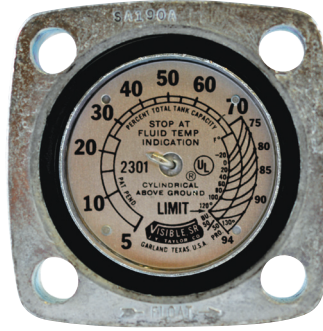

2. Ready To Glue

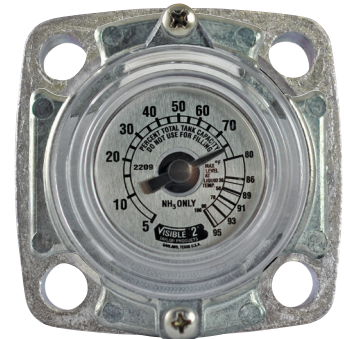

3. After Installation

*** Refer to Dial Kit Instruction Sheet For Complete Instructions, Warnings and Cautions.**

ViSible 4" Instructions

These Instructions are for the following dials - 5551T, 5520T, & 5553T.

These dials come the factory pre-assembled and are attached by placing the dial & bracket assembly over the head and tightening the two screws (Figure 1) to clamp the dial to the gauge head (Figure 2).



Complete Dial Assembly
Front View



Complete Dial Assembly
Back View

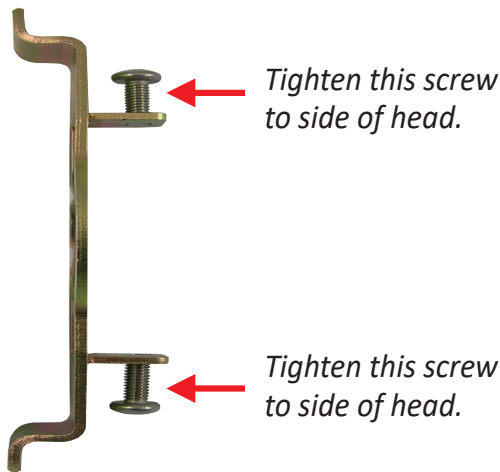

Figure 1

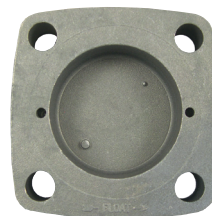

Figure 2

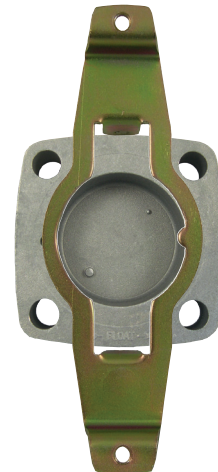

Figure 3

ViSible 4" Instructions

These Instructions are for the following dials - 2778R, 5511R, 5520R, & 5553R.

These dials will come the factory pre-assembled & need to be disassembled prior to installation.

1. Remove the two screws that attach the bezel (Figure 1) to the bracket. This will allow the bezel & dial to be removed from the bracket assembly.
2. Use the two small screws that are in the bracket to attach the bracket to the gauge head (Figure 2). NOTE the orientation of the notch that must be at the "3 o'clock position".
3. After the bracket is attached to the dial head, push the dial into the bracket & attach the bezel with the two screws that you originally removed (Figure 3).



Complete Dial Assembly
Front View



Complete Dial Assembly
Back View



Figure 1

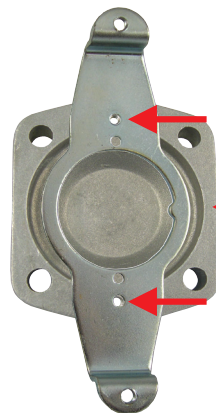

Figure 2

Attach with small screw.

3 o'clock position.

Attach with small screw.



Figure 3

New Style 3 Bracket Model B Master 8" Instructions

1. Remove dial screws from brackets on the gauge head.
2. Match the 3 holes on the dial up with 3 brackets.
3. Replace the 3 screws that you removed in step 1 & tighten them down.

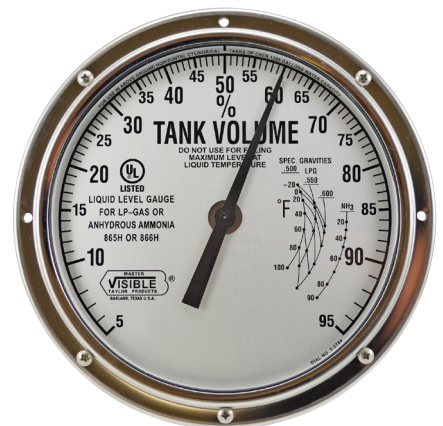

New Style Model A Master 8" Instructions

These instructions are for installing a dial on a Model A Gauge that is installed in a Tank.

1. The headstrap has screw locations @ 12 & 6 o'clock (Figure 1).
2. The Model A Dial has holes for screws @ 12 & 6 o'clock (Figure 2).
3. Place the Model A Dial over the headstrap & line up holes in the dial with the screw locations @ 12 & 6 o'clock. Attach the dial to the headstrap with the screws (Figure 3).

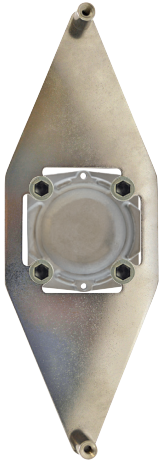

Figure 1



Figure 2



Figure 3

Old Style 2-Bracket Master 8" Instructions

These dials will come from the factory pre-assembled & needs to be disassembled prior to installation.

1. Remove the four screws & nuts that attach the brackets (Figure 1) to the dial. This will allow the brackets to be installed on the gauge head.
2. Use the two small screws that are in the bracket to attach the brackets to the gauge head (Figure 2).
3. After the brackets are attached to the gauge head, make sure that the 50% mark on the dial and top on the head matches up and attach the dial to brackets with the 4 screws and nuts that you originally removed (Figure 3).

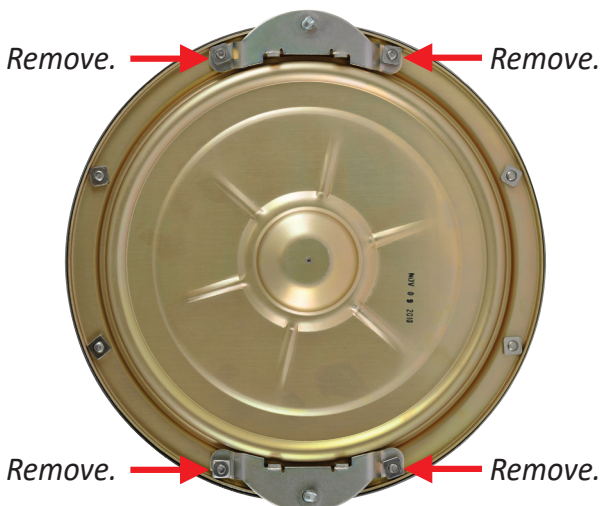

Figure 1



Figure 2

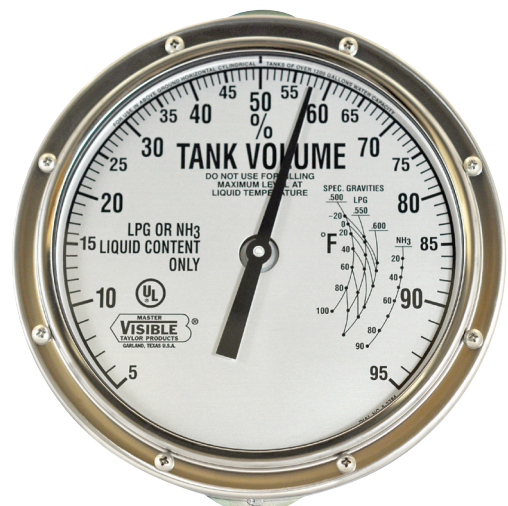

Figure 3

OFFER OF SALE

The items described in this document and other documents and descriptions provided by Squibb Taylor, Inc. and its authorized distributors ("Seller") are hereby offered for sale at prices to be established by Seller. This offer and its acceptance by any customer ("Buyer") shall be governed by all of the following Terms and Conditions. Buyer's order for any item described in its document, when communicated to Seller verbally, or in writing, shall constitute acceptance of this offer. All goods, services or work described will be referred to as "Products".

- 1. Terms and Conditions.** Seller's willingness to offer Products, or accept an order for Products, to or from Buyer is subject to these Terms and Conditions or any newer version of the terms and conditions found on-line at www.squibbtaylor.com. Seller objects to any contrary or additional terms or conditions of Buyer's order or any other document issued by Buyer.
- 2. Price Adjustments; Payments.** Prices for products covered by this Agreement may be Adjusted by the seller at any time prior to shipment and regardless of the acceptance of the issuance of a sales confirmation, to reflect any increase in Sellers's net price or cost of raw materials. This does not include sales, use, or other taxes unless specifically stated. Unless otherwise specified by Seller, all prices are F.C.A. Seller's facility (INCOTERMS 2010). Payment is subject to credit approval and is due 30 days from the date of invoice or such other term as required by Seller's Credit Department, after which Buyer shall pay interest on any unpaid invoices at the rate of 1.5% per month or the maximum allowable rate under applicable law.
- 3. Delivery Dates; Title and Risk; Shipment.** All delivery dates are approximate and Seller shall not be responsible for any damages resulting from any delay. Regardless of the manner of shipment, title to any products and risk of loss or damage shall pass to Buyer upon placement of the products with the shipment carrier at Seller's facility. Unless otherwise stated, Seller may exercise its judgment in choosing the carrier and means of delivery. No deferment of shipment at Buyers' request beyond the respective dates indicated will be made except on terms that will indemnify, defend and hold Seller harmless against all loss and additional expense. Buyer shall be responsible for any additional shipping charges incurred by Seller due to Buyer's acts or omissions.
- 4. Warranty.** Seller warrants that the Products sold hereunder shall be free from defects in material or workmanship for a period of twelve months from the date of delivery to Buyer or 2,000 hours of normal use, whichever occurs first. The prices charged for Seller's products are based upon the exclusive limited warranty stated above, and upon the following disclaimer: **DISCLAIMER OF WARRANTY: THIS WARRANTY COMPRISES THE SOLE AND ENTIRE WARRANTY PERTAINING TO PRODUCTS PROVIDED HEREUNDER. SELLER DISCLAIMS ALL OTHER WARRANTIES, EXPRESS AND IMPLIED, INCLUDING DESIGN, MERCHANTABILITY AND FITNESS FOR A PARTICULAR PURPOSE.**
- 5. Claims; Commencement of Actions.** Buyer shall promptly inspect all Products upon delivery. No claims for shortages will be allowed unless reported to the Seller within 10 days of delivery. No other claims against Seller will be allowed unless asserted in writing within 30 days after delivery. Buyer shall notify Seller of any alleged breach of warranty within 30 days after the date the defect is or should have been discovered by Buyer. Any action based upon breach of this agreement or upon any other claim arising out of this sale (other than an action by Seller for an amount due on any invoice) must be commenced within 12 months from the date of the breach without regard to the date breach is discovered.
- 6. LIMITATION OF LIABILITY.** UPON NOTIFICATION, SELLER WILL, AT ITS OPTION, REPAIR OR REPLACE A DEFECTIVE PRODUCT, OR REFUND THE PURCHASE PRICE. **IN NO EVENT SHALL SELLER BE LIABLE TO BUYER FOR ANY SPECIAL, INDIRECT, INCIDENTAL OR CONSEQUENTIAL DAMAGES ARISING OUT OF, OR AS THE RESULT OF, THE SALE, DELIVERY, NON-DELIVERY, SERVICING, USE OR LOSS OF USE OF THE PRODUCTS OR ANY PART THEREOF, OR FOR ANY CHARGES OR EXPENSES OF ANY NATURE INCURRED WITHOUT SELLER'S WRITTEN CONSENT, EVEN IF SELLER HAS BEEN NEGLIGENT, WHETHER IN CONTRACT, TORT OR OTHER LEGAL THEORY. IN NO EVENT SHALL SELLER'S LIABILITY UNDER ANY CLAIM MADE BY BUYER EXCEED THE PURCHASE PRICE OF THE PRODUCTS.**
- 7. User Responsibility.** The user, through its own analysis and testing, is solely responsible for making the final selection of the system and Product and assuring that all performance, endurance, maintenance, safety and warning requirements of the application are met. The user must analyze all aspects of the application and follow applicable industry standards and Product information. If Seller provides Product or system options, the user is responsible for determining that such data and specifications are suitable and sufficient for all applications and reasonably foreseeable uses of the Products or systems.
- 8. Loss to Buyer's Property.** Any designs, tools, patterns, materials, drawings, confidential information or equipment furnished by Buyer or any other items which become Buyer's property, will be considered obsolete and may be destroyed by Seller after two consecutive years have elapsed without Buyer ordering the items manufactured using such property. Seller shall not be responsible for any loss or damage to such property while it is in Seller's possession or control.
- 9. Special Tooling.** A tooling charge may be imposed for any special tooling, including without limitation, dies, fixtures, molds and patterns, acquired to manufacture Products. Such special tooling shall be and remain Seller's property notwithstanding payment of any charges by Buyer. In no event will Buyer acquire any interest in apparatus belonging to Seller which is utilized in the manufacture of the Products, even if such apparatus has been specially converted or adapted for such manufacture and notwithstanding any charges paid by Buyer. Unless otherwise agreed, Seller shall have the right to alter, discard or otherwise dispose of any special tooling or other property in its sole discretion at any time.
- 10. Buyer's Obligation; Rights of Seller.** To secure payment of all sums due or otherwise, Seller shall retain a security interest in the goods delivered and this agreement shall be deemed a Security Agreement under the Uniform Commercial Code. Buyer authorizes Seller as its attorney to execute and file on Buyer's behalf all documents Seller deems necessary to perfect its security interest.
- 11. Improper use and Indemnity.** Buyer shall indemnify, defend, and hold Seller harmless from any claim, liability, damages, lawsuits, and costs (including attorney fees), whether for personal injury, property damage, patent, trademark or copyright

- infringement or any other claim, brought by or incurred by Buyer, Buyer's employees, or any other person, arising out of: (a) improper selection, improper application or other misuse of Products purchased by Buyer from Seller; (b) any act or omission, negligent or otherwise, of Buyer; (c) Seller's use of patterns, plans, drawings, or specifications furnished by Buyer to manufacture Product; or (d) Buyer's failure to comply with these terms and conditions. Seller shall not indemnify Buyer under any circumstance except as otherwise provided.
- 12. Cancellations and Changes.** Orders shall not be subject to cancellation or change by Buyer for any reason, except with Seller's written consent and upon terms that will indemnify, defend and hold Seller harmless against all direct, incidental and consequential loss or damage. Seller may change product features, specifications, designs and availability with notice to Buyer.
 - 13. Limitation on Assignment.** Buyer may not assign its rights or obligations under this agreement without the prior written consent of Seller.
 - 14. Force Majeure.** Seller does not assume the risk and shall not be liable for delay or failure to perform any of Seller's obligations by reason of circumstances beyond the reasonable control of Seller (hereinafter "Events of Force Majeure"). Events of Force Majeure shall include without limitation: accidents, strikes or labor disputes, acts of any government or government agency, acts of nature, delays or failures in delivery from carriers or suppliers, shortages of materials, or any other cause beyond Seller's reasonable control.
 - 15. Waiver and Severability.** Failure to enforce any provision of this agreement will not waive that provision nor will any such failure prejudice Seller's right to enforce that provision in the future. Invalidation of any provision of this agreement by legislation or other rule of law shall not invalidate any other provision herein. The remaining provisions of this agreement will remain in full force and effect.
 - 16. Termination.** Seller may terminate this agreement for any reason and at any time by giving Buyer thirty (30) days written notice of termination. Seller may immediately terminate this agreement, in writing, if Buyer: (a) commits a breach of any provision of this agreement (b) appointments a trustee, receiver or custodian for all or any part of Buyer's property (c) files a petition for relief in bankruptcy on its own behalf, or by a third party (d) makes an assignment for the benefit of creditors, or (e) dissolves or liquidates all or a majority of its assets.
 - 17. Governing Law.** This agreement and the sale and delivery of all Products hereunder shall be deemed to have taken place in and shall be governed and construed in accordance with the laws of the State of Texas, as applicable to contracts executed and wholly performed therein and without regard to conflicts of laws principles. Buyer irrevocably agrees and consents to the exclusive jurisdiction and venue of the courts of Dallas County, Texas with respect to any dispute, controversy or claim arising out of or relating to this agreement.
 - 18. Indemnity for Infringement of Intellectual Property Rights.** Seller shall have no liability for infringement of any patents, trademarks, copyrights, trade dress, trade secrets or similar rights except as provided in this Section. Seller will defend and indemnify Buyer against allegations of infringement of U.S. patents, U.S. trademarks, copyrights, trade dress and trade secrets ("Intellectual Property Rights"). Seller will defend at its expense and will pay the cost of any settlement or damages awarded in an action brought against Buyer based on an allegation that a Product sold pursuant to this Agreement infringes the Intellectual Property Rights of a third party. Seller's obligation to defend and indemnify Buyer is contingent on Buyer notifying Seller within ten (10) days after Buyer becomes aware of such allegations of infringement, and Seller having sole control over the defense of any allegations or actions including all negotiations for settlement or compromise. If a Product is subject to a claim that it infringes the Intellectual Property Rights of a third party, Seller may, at its sole expense and option, procure for Buyer the right to continue using the Product, replace or modify the Product so as to make it non infringing, or offer to accept return of the Product and return the purchase price less a reasonable allowance for depreciation. Notwithstanding the foregoing, Seller shall have no liability for claims of infringement based on information provided by Buyer, or directed to Products delivered hereunder for which the designs are specified in whole or part by Buyer, or infringements resulting from the modification, combination or use in a system of any Product sold hereunder. The foregoing provisions of this Section shall constitute Seller's sole and exclusive liability and Buyer's sole and exclusive remedy for infringement of Intellectual Property Rights.
 - 19. Entire Agreement.** This agreement contains the entire agreement between the Buyer and Seller and constitutes the final, complete and exclusive expression of the terms of sale. All prior or contemporaneous written or oral agreements or negotiations with respect to the subject matter are herein merged.
 - 20. Compliance with Law, U. K. Bribery Act and U.S. Foreign Corrupt Practices Act.** Buyer agrees to comply with all applicable laws and regulations, including both those of the United Kingdom and the United States of America, and of the country or countries of the Territory in which Buyer may operate, including without limitation the U. K. Bribery Act, the U.S. Foreign Corrupt Practices Act ("FCPA") and the U.S. Anti-Kickback Act (the "Anti-Kickback Act"), and agrees to indemnify and hold harmless Seller from the consequences of any violation of such provisions by Buyer, its employees or agents. Buyer acknowledges that they are familiar with the provisions of the U. K. Bribery Act, the FCPA and the Anti-Kickback Act, and certifies that Buyer will adhere to the requirements thereof. In particular, Buyer represents and agrees that Buyer shall not make any payment or give anything of value, directly or indirectly to any governmental official, any foreign political party or official thereof, any candidate for foreign political office, or any commercial entity or person, for the purpose of influencing such person to purchase products or otherwise benefit the business of Seller.

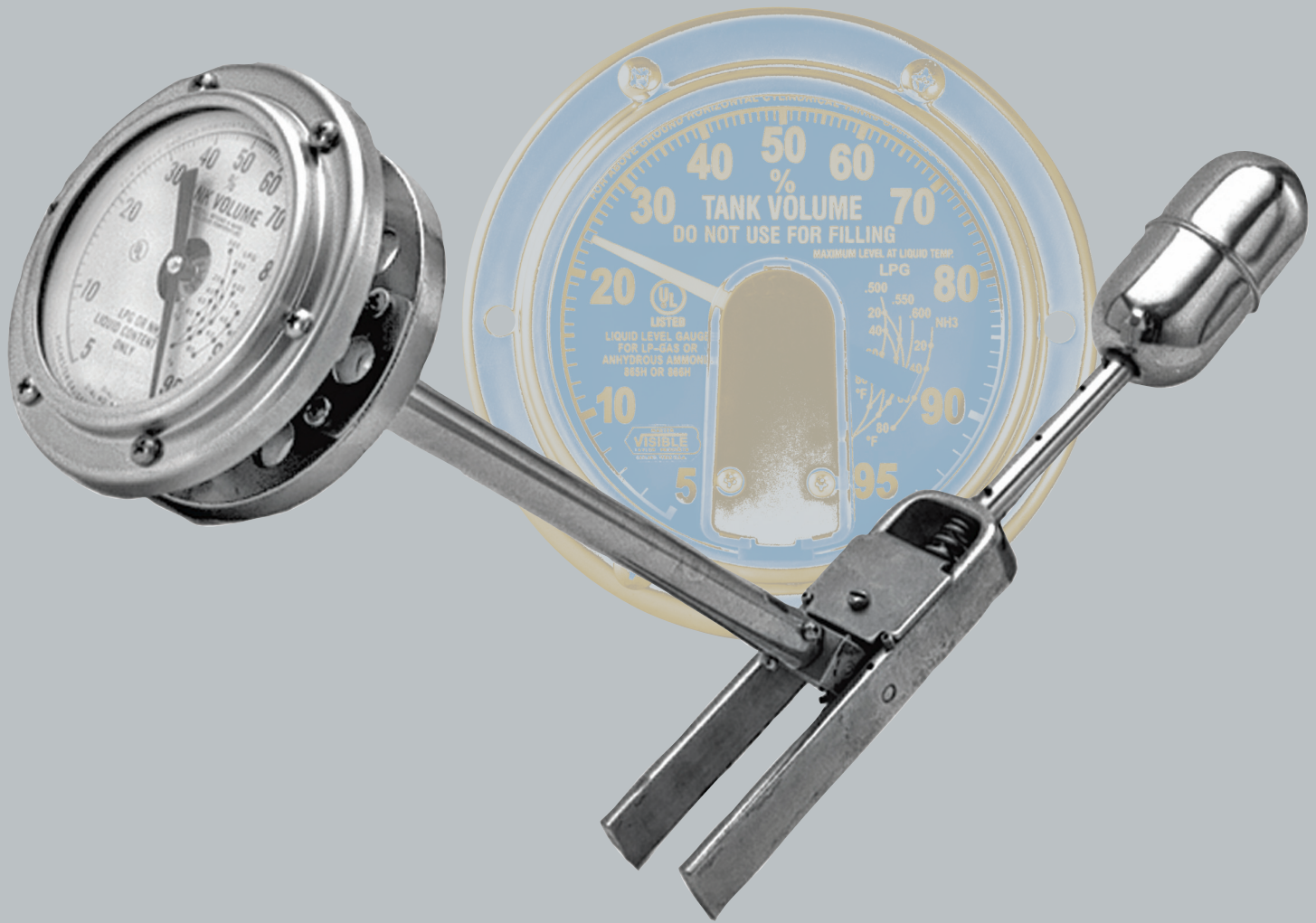

Your Distributor Is: